



# Surface Roughness Prediction in Grinding Ti using ANFIS Hybrid Algorithm

Deborah Serenade Stephen<sup>a\*</sup>, & Sethuramalingam Prabhu<sup>b</sup>

<sup>a</sup>Department of Mechanical Engineering, SRM Institute of Science and Technology, Chennai 603 203, India;

<sup>b</sup>Department of Mechanical Engineering, SRM Institute of Science and Technology, Chennai 603 203, India

Received: 16 March 2021; Accepted: 21 September 2021

Intelligent manufacturing is needed, and many techniques and tools have been developed with this in mind. Over time, many of these techniques have been combined, and hybrid approaches have provided better results in shorter times, leading to a more precise prediction of outcomes when compared to the use of individual tools. This research focused on grinding Ti-6Al-4V workpiece material with a Carbon nanotube (CNT) incorporated grinding wheel. The Adaptive Neuro-Fuzzy Inference System (ANFIS) was used to predict surface roughness which was taken as the output of choice for this study. A new hybrid of ANFIS with Genetic Algorithm (ANFIS-GA) was then proposed to see if this prediction method could obtain greater precision. The regression analysis predicted the experimental model's linear relationship to surface roughness, and the effect of grinding process parameters on surface roughness was analysed using the sensitivity analysis method.

**Keywords:** ANFIS, CNT Grinding wheel, Fuzzy logic, Regression analysis, Sensitivity analysis, Taguchi analysis

## 1 Introduction

The grinding process is economically feasible to improve the surface finish of brittle and hard materials like Ti-6Al-4V and Inconel. To achieve a nano surface finish on these metals purely depends upon input and noise factors such as depth of cut, cutting speed, feed, vibration and tool wear. These factors rely entirely on an operator's experience and knowledge and can sometimes produce poor grinding results. It is engaging to see that this challenge of operator's liability can be reduced with feed-forward mapping and explained using regression and sensitivity analysis. Prediction of outcomes and hybridisation of different techniques have also enhanced the scope of intelligent machining. Thus, modelling and analysis using suitable neuro-fuzzy systems like ANFIS have proved to be a motivating field of investigation, capable of carrying out online feed-forward mapping. Recent literature has shown that many researchers utilise these techniques to predict models effectively and optimise surface roughnesses intelligently.

Jesuthanam<sup>1</sup> proposed that the highest productivity can be achieved by practically evaluating surface roughness. However, predicting surface roughness is a challenge since variable machining parameters govern it. Therefore, they have proposed using hybrid neural networks with a Genetic Algorithm (GA) or Particle

Swarm Optimization (PSO) to predict surface roughness.

Hashmi *et al.*<sup>2</sup> have applied the fuzzy logic concept to machining operations for selecting cutting parameter levels. Medium carbon leaded steel (BHN 125-425) data was used for theoretical calculations, and Mamdani fuzzy expert system model was developed to predict the results precisely that confirmational experimentation was unnecessary. Prabhu *et al.*<sup>3</sup> developed a surface roughness prediction model using an artificial neural network for grinding with nanofluids. The Levenberg–Marquardt algorithm in feed-forward artificial neural networks was used to train the system. Before this, such work was not carried out using a CNT grinding wheel to grind AISI D2 tool steel. Taguchi's design was used to conduct the experiments, and ANOVA was used to identify significant parameters of the process. Comparison between the predicted and experimental values were done and found to be in good agreement.

Fuzzy logic (FL) can be used along with many techniques, and hybrid approaches have been undertaken to improve the prediction precision of the outcome. The following examples where FL has been used with grey-fuzzy reasoning grade for a compliant mechanism<sup>4</sup>, with Taguchi method in the multi-objective optimisation of product form design<sup>5</sup> are testaments to the success of this hybridisation. ANFIS with the Taguchi method has also been used for a linear compliant mechanism<sup>6</sup>.

\*Corresponding author (Email: deborahs@srmist.edu.in)

Pandiyan *et al.*<sup>7</sup> have used six different regression techniques, including ANN, ANFIS and multiple linear regression, to accurately model material removal in the belt grinding process. Taguchi's design of experiments was used to conduct experiments, and the overall comparison of methods shows that the ANFIS approach served well on many fronts. Interpreting the relationship between input and output parameters was only possible with ANFIS, as the maximum association between predicted and experimental values of material removal rates were the best in this method

Baraheni *et al.*<sup>8</sup> have used ANFIS for optimising design parameters in a grinding process. At the same time, Baseri *et al.*<sup>9</sup> have employed it to model surface roughness in grinding from a dresser point-of-view. He has also employed fuzzy logic and neural networks to study the sharpness of grinding wheels<sup>10</sup>. Dambatta *et al.*<sup>11</sup> have used the ANFIS technique to successfully predict specific grinding forces and surface roughness in the grinding of Al6061-T6 alloy.

From all the above literature and more, a few points stood out. First, experiments were to be carried out using Taguchi's DOE for the best coverage of all parameter variations economically and within the available timeframe. Hence the L<sub>9</sub> Orthogonal array was chosen to design the experiments with the speed of the grinding wheel (S), feed (F) and depth of cut (D) as the three parameters of interest. The second was that, once the experimental values were obtained, some system had to be put in place for choosing optimal parameters instantaneously by future users of the process, which required a background that would accurately predict surface roughness values for the chosen parameters.

Thirdly, among the many methods studied for accurate predictions of parameters like surface roughness, material removal rates, and effectiveness among many such others, the ANFIS method has stood out consistently, proving the best possible method. However, the catch is that it seems to function best when used in tandem with other algorithms rather than on its own. All these inputs motivated this study, and the decision to use a hybrid of ANFIS with GA using the fuzzy logic toolbox of MATLAB was reached.

Mamalis *et al.*<sup>12</sup> briefed about the properties, applications and production methods of Carbon Nano Tubes (CNTs), and the available information created interest among researchers and engineers alike. The excellent properties of CNTs inspired their use directly in grinding wheels. You *et al.*<sup>13</sup> have conducted

nanomachining using CNTs to enhance the cutting tool's thermal and mechanical properties. CNTs have been used directly as cutting grains, and a CNT grinding wheel was designed and manufactured. It acted as a new type of abrasive composite, and results showed enhanced protrusion of the grains, thereby allowing for longer life of the grinding wheel. Bakshi *et al.*<sup>14</sup> have used Carbon Nano Tubes (CNTs) in an Aluminum matrix to study their effect on the strengthening of a composite. Graphs and tables with varying percentages of CNT and their effects on strength parameters have also been recorded. Bansal *et al.*<sup>15</sup> studied the effects of combining MWCNTs with polypropylene in variations of 5 and 10% and observed that for the 10% inclusion, strength and hardness increased by 27.5% and 75%, respectively.

However, all these approaches use CNT as composite reinforcement, and their effects have been indirect. This research, however, uses CNTs as cutting grains directly to study their effects on the surface roughness of hard-to-machine material like Ti-6Al-4V. The multi-walled carbon nanotubes (MWCNT) type 4 with 95% purity were purchased from Sisco Research Labs, Chennai, India.

There is a considerable increase in the machining capability of a material when MWCNT particles are included in small quantities by weight. Reduced tool wear, improved material removal rate, improved vibration damping characteristics, and lower tool forces are some of the advantages of this grinding wheel. This wheel has been developed to eliminate problems like frequent truing from grinding hard metals like Titanium, which result in lost time, tool surface and lower wheel life. Experiments conducted with a wheel made by incorporating 2% MWCNT by weight into the cubic Boron Nitride (CBN) grinding wheel were used to determine surface roughness in machining Ti-6Al-4V. They proved and agreed with existing literature that the incorporation of nanoparticles reduced the surface roughness of the ground material. Their key benefit was that surface grinding as a finishing process allows smoother surfaces to be produced compared to conventional turning or milling processes.

## 2 Materials and Methods

The experimental setup consisted of a CNT grinding wheel mounted on the horizontal spindle of the surface grinding machine (Avro, CBE). The surface grinding machine had a table that could move on two axes, and a specialised fixture was mounted on the dynamometer and bolted to the table. This fixture

held the test pieces in place. Each Ti workpiece was 25.4 x 25.4 x 25.4 mm in dimension, and four surfaces were machine while the remaining surfaces were used for clamping.  $L_9$  orthogonal array (OA) was used to conduct the experiments and to determine Surface Roughness ( $R_a$ ). Two wheels – a CBN grinding wheel and the 2%CNT incorporated wheel were manufactured according to the dimensions required for the grinding machine, outer diameter - 250 mm, inner diameter - 76.2 mm and thickness of the wheel 20 mm, were used to conduct the experiments. The wheels were electroplated on a mild steel base for a thickness of about 3mm, as seen in Fig. 1.

### 2.1 Topography analysis on CNT grinding wheel with SEM analysis

A 10x10x10 mm mild steel piece coated with CBN and 2%CNT on its surface was manufactured, as shown in Fig. 2(a), and the Scanning Electron Microscopic (SEM) analysis was conducted. The images were obtained to identify the presence of the CNTs in the CBN matrix at different magnifications,

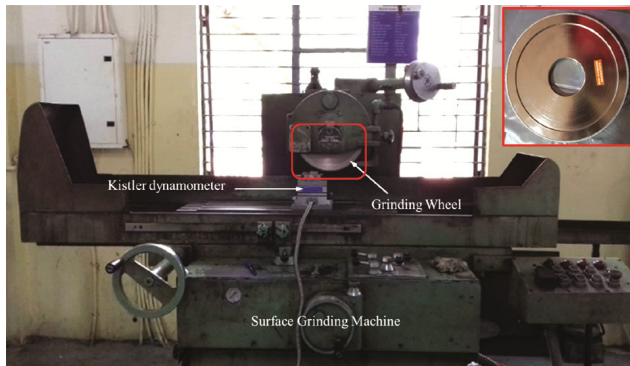

Fig. 1 — 2% CNT incorporated CBN grinding wheel on the surface grinding machine.

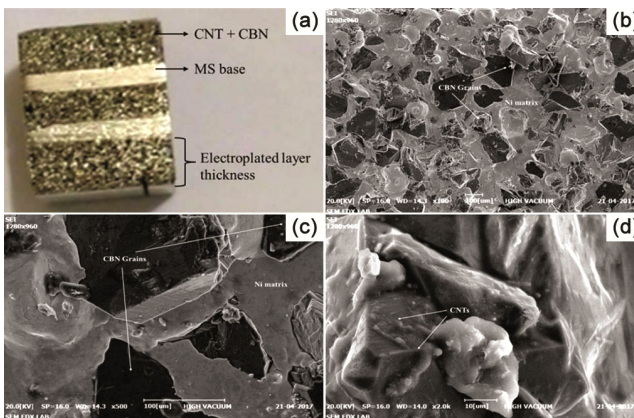

Fig. 2 — SEM image of A) SEM sample for CNT-CBN Wheel, B) CBN+CNT infused grinding wheel with 100  $\mu$ m, C) Pure CBN Grain structure wheel and D) CNT infused CBN with magnification 10 $\mu$ m.

i.e., 10  $\mu$ m and 100  $\mu$ m, as seen in Fig. 2(b&c). This analysis proved the presence of CNT particles in the CNT-CBN wheel. Figure 2(a) shows the image of the CBN + CNT sample grinding wheel layers, and the presence of CNT can be seen as thin fibre-like layers, as shown in Figure 2(d) at the magnification of 2000x.

CNT inclusion is advantageous because it functions directly as cutting grains and allows more metal removal with an acceptable surface finish and longer intervals between two successive wheel dressings. On analysing the wheels after grinding, it was observed that the commercially available CBN grinding wheel showed more dislodgement of particles and non-uniform adhesion of the CBN particles. Improper adhesion led to less heat absorption and release to the workpiece surface. However, the high thermal conductivity and heat dissipation capacity of CNT nanotubes led to an improved surface finish of hard and difficult-to-machine metals like Titanium. CNT grinding wheel with uniform bonding characteristics led to good strength and cutting force absorption capacity, so that vibration and chatter were minimised. All this led to the generation of nano surface finish on hard materials.

### 2.2 Surface roughness analysis of Ti

The surface roughnesses of all Ti workpieces were analysed using Surfcom 1400G surface roughness tester. The Surfcom roughness measuring instrument has a movable stylus with a ruby-tipped probe. The probe traces an evaluation length 'L' of 4mm, and the roughness is measured based on the Centre Line Average (CLA) method, also denoted as ' $R_a$ ' values. It is the arithmetic average of the absolute values of the profile heights over the evaluation length<sup>16</sup>. The surface roughness is calculated according to Eq (1).

$$R_a = \frac{1}{n} \sum_{i=1}^n |y_i| \quad \dots (1)$$

Three runs with the probe were taken across the lay on each surface, and the average of these three readings was recorded as the surface roughness. This procedure was carried out for all surfaces, and the readings were analysed. The setup is shown in Fig. 3.

## 3 Results and Discussions

### 3.1 Taguchi experimental grinding process

In this nano grinding wheel study, the  $L_9$  orthogonal array design was used for experimentation. The experimental surface roughness values are depicted in Fig 4.

The noise factors like distortion, spindle accuracy, work position and heat generation were assumed to be negligible and to have minimal effect on the experimentation. S/N ratio was calculated based on the objective functions of the investigation, and this experimentation aimed to improve the surface finish of the grinding process using CNT-CBN grinding wheels. For this, smaller-the-better surface roughness was chosen, three replicates were measured, and randomised experimentation with blocking was carried out for the grinding wheel. The formula for the S/N ratio for smaller-the-better was shown in Eq (2).

$$\frac{S}{N} \text{ Ratio } (\eta) = -10 \log_{10} \frac{1}{n} \sum_{i=1}^n y^2 \quad \dots (2)$$

where n= number of replicates and y = number of responses

For the commercially bought CBN wheel, level 1 of speed (A1), level 3 of feed (B3) and level 2 of the depth of cut (C2) offered the best increase in surface



Fig. 3 — Surface roughness measurement setup.

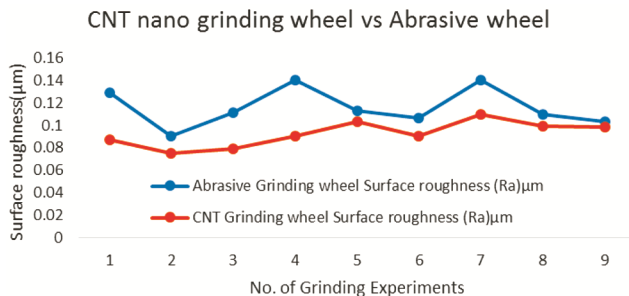

Fig. 4 — Surface roughness of CNT nano and abrasive grinding process

finish. A1, B2 and C2 gave optimum value for the CNT-CBN grinding wheel, where A1, B3 and C2 pertained to a cutting speed of 2000 rpm, 900 mm/min of feed and 0.1 mm depth of cut. Using these optimal levels of grinding parameters, the predicted S/N ratio  $\hat{\eta}$  was calculated using Eq (3).

$$\hat{\eta} = \eta_m + \sum_{i=1}^p \eta_i - \eta_m \eta = \eta_m + \sum_{i=1}^p (\eta_i - \eta_m) \dots (3)$$

Where  $\eta_m$  – Total mean of the S/N ratio,  $\eta_i$ - Mean of optimal level S/N Ratio and p-Number of parameters.

The experimental surface roughness obtained was  $0.09 \mu\text{m}$ , compared with the predicted Taguchi surface roughness of  $0.108 \mu\text{m}$  for the CBN grinding wheel. For CNT-CBN wheel, the predicted value was  $0.086 \mu\text{m}$ , and the actual experimental surface roughness was  $0.079 \mu\text{m}$ . Cutting speed proved to have a significant influence in comparison with the other two parameters, and this effect was also visible from the surface analysis.

It could be seen that optimisation of machining parameters increased the practicality of grinding and substantially increased the quality of the product. The confirmation experiment was the final step in the design of experiments. This experiment was done to validate the conclusion arrived during the analysis phase. These experiments were conducted at optimum parameter levels, determined using Taguchi analysis and compared with predicted values of the objective function. Here, for the CBN wheel, cutting speed at 2000 rpm, feed of 600 mm/min and depth of cut as 0.1 mm were used to obtain the surface roughness of 0.09 and compared with the predicted surface roughness of  $0.108 \mu\text{m}$ . Similarly, the confirmation test was carried out for the CNT grinding wheel and the surface roughness acquired was  $0.079 \mu\text{m}$  compared with a prediction of  $0.086 \mu\text{m}$ .

### 3.2 Regression analysis

Regression models determine the degree of relationship between a dependent variable and an independent one. Here the depth of cut, feed and speed were used as independent variables and surface roughness as the dependent variable. Empirical models were derived based on grinding experiments, as seen from Eqs (4) and (5).

Surface roughness (Ra) with CBN grinding wheel

$$(Y) = 0.123 S^{0.000006} f^{-0.000049} d^{0.063} \quad \dots (4)$$

Surface roughness (Ra) with CNT grinding

$$\text{wheel}(Y) = 0.046 S^{0.000018} f^{-0.000011} d^{0.0533} \quad \dots (5)$$

Where Y = Surface roughness ( $\mu\text{m}$ ), S = Cutting speed (rpm), f = Feed (mm/min), d = Depth of cut (mm)

Results of the regression analysis were compared with nine sets of experiments. The average error was 5.14 % for the regression model using a commercially available CBN grinding wheel, while CNT was 0.87 %. This method was suitable for estimating surface roughness within tolerance ranges. From the results, it could be seen that the % error was lesser for grinding with the CNT-CBN wheel. The  $R^2$  value of the regression model with the CNT-CBN wheel was 0.999, and for CBN grinding wheel, 0.628. The high  $R^2$  value indicated a better model fit. The CNT-CBN grinding wheel had the best model fit based on the values obtained.

**3.3 Absolute sensitivity analysis of the Depth of cut (D), Speed(S) and Feed (F)**

The purpose of sensitivity analysis was to identify objective functions of surface roughness, and the empirical formula for surface roughness was concluded as shown in Eqs (6) and (7).

$$\text{Surface Roughness}(R_a) \text{ with abrasive Grinding wheel}(\sigma_x) = 0.123 S^{0.000006} f^{-0.000049} d^{0.063} \dots (6)$$

$$\text{Surface Roughness}(R_a) \text{ with CNT Grinding wheel}(\sigma_y) = 0.0460 S^{0.000018} f^{-0.000011} d^{0.0533} \dots (7)$$

Calculating sensitivity analysis for surface roughness obtained for the cutting speed, depth of cut and feed of CBN grinding wheel was done as shown in Eqs (8) – (10).

$$\frac{\partial \sigma_x}{\partial S} = 0.000000738 S^{-0.99994} f^{-0.000049} d^{0.063} \dots (8)$$

$$\frac{\partial \sigma_x}{\partial F} = -0.000006027 S^{0.000006} f^{-1.000049} d^{0.063} \dots (9)$$

$$\frac{\partial \sigma_x}{\partial D} = 0.007749 S^{0.000006} f^{-0.000049} d^{-0.937} \dots (10)$$

Calculated sensitivity analysis for surface roughness obtained for the cutting speed, depth of cut and feed of CNT incorporated CBN grinding wheel was done as shown in Eqs (11) – (13).

$$\frac{\partial \sigma_y}{\partial S} = 0.000000828 S^{-0.999982} f^{-0.000011} d^{0.0533} \dots (11)$$

$$\frac{\partial \sigma_y}{\partial F} = -0.0459 S^{0.000018} f^{-1.000011} d^{0.0533} \dots (12)$$

$$\frac{\partial \sigma_y}{\partial D} = 0.0024518 S^{0.000006} f^{-0.000049} d^{-0.9467} \dots (13)$$

According to Eqs (10)-(12), the absolute sensitivity analysis of surface roughness for depth of cut, cutting

speed and feed of CBN grinding wheel were obtained as depicted in Fig. 5. When the depth of cut (D) for grinding with the CBN wheel was 0.05mm, the sensitivity analysis of  $\sigma_x : D$  was more prominent than others, as S and F were unchanged. The cutting speed of the grinding process was lesser and negatively distributed, while feed was minimal and could not be represented in this sensitivity analysis. The surface finish accuracy in grinding with the CBN wheel showed maximum distribution in the negative direction, which indicated variations in surface roughness. The feed(F) parameter was less negatively distributed, which showed that it had the most negligible influence on surface roughness.

**3.4 Adaptive Neuro-Fuzzy Interference System (ANFIS) architecture**

ANFIS-an intelligent Fuzzy-Neuro hybrid learning algorithm technique, was used as a predictive model of an uncertain system. The Sugeno-type fuzzy inference engine was used to define rules based on expertise, knowledge and experience. This architecture had five layers, as depicted in Fig. 6. Rectangular boxes were used to represent the first layer, with three input variables cutting speed(X),

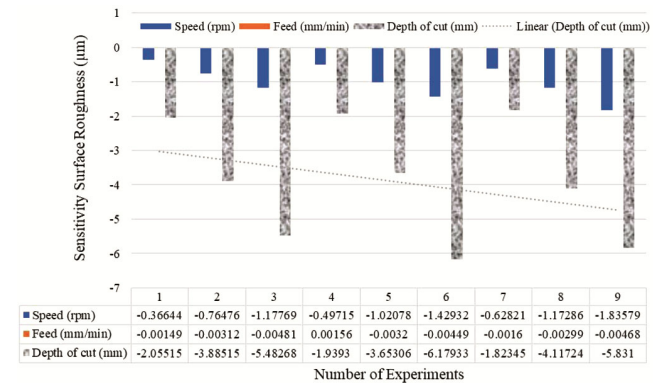

Fig. 5 — Sensitivity of Surface roughness to Distance (D), Pressure (P) and Speed (S).

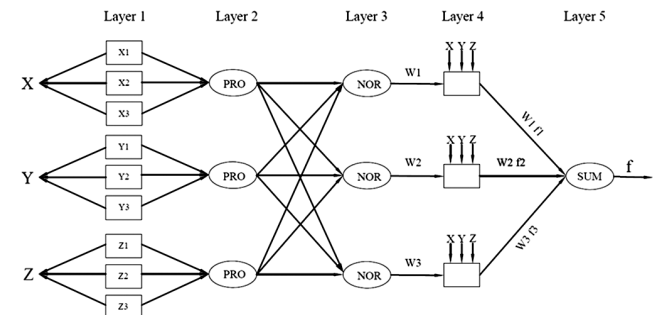

Fig. 6 — ANFIS architecture of feed-forward network mapping of CNT-CBN grinding process.

feed (Y) and depth of cut (Z). The circles represent hidden layers 2 and 3, with fixed values of weighted residuals.

Layer1: M1, every  $j^{\text{th}}$  node of layer 1, had an output I and a node function.  $M1, j = \mu P_j(x)$  for  $j = 1, 2$ , or  $M1, J = \mu Q_{j-2}(x)$  for  $j = 3, 4$ , x, y (or z) was the input node j and  $X_i, Y_i$  and  $Z_i$ , the linguistic labels associated with this node, Therefore, for M1, j was the membership grade of a fuzzy set (X1, X2, X3, Y1, Y2, Y3, Z1, Z2, Z3).

Layer 2: There was a fixed node labelled PRO for every node in this layer. The output was the product of all input parameter signals, as shown in Eq (14).

$$M2, j = w_j = \mu P_i(x) * \mu Q_i(y) \quad \dots (14)$$

Each node constituted the firing strength of the rule, and any other T-norm operator that performed the AND operation could be used.

Layer 3: NOR was the name of every node in this layer and is calculated as per Eq (15).

$$\text{NOR } j^{\text{th}} \text{ node} = \frac{j^{\text{th}} \text{ rule's firing strength}}{\text{Sum of all the rules firing strength}} \dots (15)$$

$$M3, j = w_j = \frac{w_j}{(w_1 + w_2)} \quad \dots (16)$$

$J=1, 2, \dots$ , 'Normalized Firing Strengths' was the name for all outputs

Layer 4: Every node j in this layer was an adaptive node with a node function as shown in Eq (17)

$$M4,1 = w_j f_i = w_j (P_i x + q_i y + r_i z + S_i) \quad \dots (17)$$

$W_j$  was the normalised firing strength from layer 3.

$\{p_i, q_i, r_i\}$  were consequent parameters and were the parameters set of this node.

Layer 5: The overall output was the sum of all incoming signals as calculated from Eq (18), and was a single, fixed node labelled 'sum'.

$$\text{Over all output} = M5,1 = \sum_j W_j f_i = \frac{\sum W_j f_i}{\sum W_j} \dots (18)$$

As shown in Table 1, ANFIS could be trained. During the forward pass, the least-square method was used to recognise consequent parameters on layer 4. The errors were bred backwards for the backwards pass, and a gradient descent approach was used to upgrade parameters.

### 3.5 Fuzzy logic analysis of the CNT Grinding process

All possible values of variables contained in the fuzzy set could be identified. This study describes a

multi-input, single-output (MISO) system. It included three inputs – feed, cutting speed and depth of cut and one output of Ti-6Al-4V - Surface Roughness (SR). A possible universe of discourse for all the input parameters with their various levels is given in Table 2.

In ANFIS, training data was established by combining inputs like depth of cut, cutting speed and feed. This data was used to get surface roughness output parameters for carbon nanotube-based grinding. The quality of training data determined the accuracy with which neural networks calculated their output. The way training data was obtained from the grinding process is shown in Fig. 7. Calculations of membership functions were found using the fuzzy logic toolbox to adapt training data.

Human reasoning in linguistic terms could be modelled using fuzzy logic as this allowed vague reasoning. It defined input-output relationships quite satisfactorily. The system consisted of a fuzzifier that converted crisp inputs to fuzzy sets, an inference engine that performed reasoning using fuzzy rules to create fuzzy values, a database, rule base, and defuzzifier that reconverted those values back into the crisp output. The ANFIS model training data was obtained for the CNT-CBN grinding wheel with the 3 input process parameters, and the data file was generated. Taguchi's design of experiments was used to analyse data and was given to the ANFIS feed-forward and back propagation model to test the model's accuracy.

### 3.6 Fuzzy logic Approach

Much knowledge could be gained from the skill and experience of machinists developed over the years, and this was useful to decide upon optimum grinding parameters. In fuzzy logic, human language was modelled in terms and words that are simple enough to be understood even by unskilled operators. This reduced ambiguity increases the rates of successful operation. Sugeno fuzzy inference method

Table 1 — ANFIS hybrid learning algorithm

	Forward Pass	Backward Pass
Premise Parameters	Fixed	Gradient Descent
Consequent Parameters	Least square estimators	Fixed
Signals	Node outputs	Error signal

Table 2 — Input parameters and their levels

Code	Control Factors	Low	Medium	High
A	Speed (rpm)	2000	2600	3200
B	Feed (mm/min)	300	600	900
C	Depth of cut (mm)	0.05	0.1	0.15

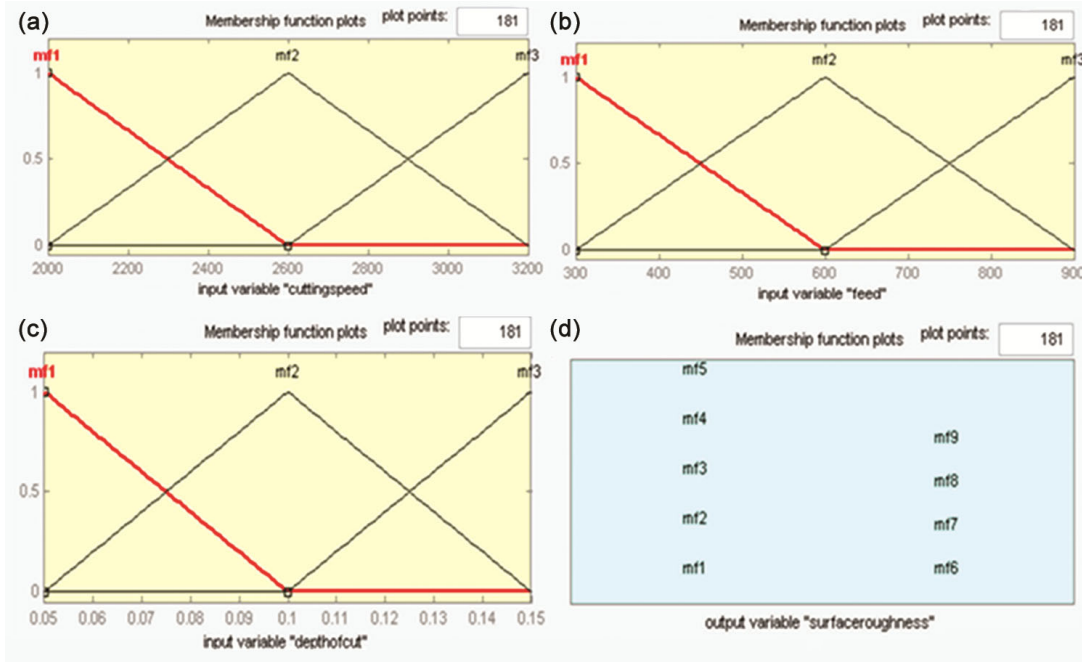

Fig. 7 — (a) Membership functions of cutting speed, (b) feed (c), depth of cut, and (d) output function surface roughness.

was used to predict the accuracy of dimensions for particular parameter combinations of feed, speed and depth of cut. The fuzzy membership shape was first chosen for all three parameters to establish the model.

The input and output ranges were first identified to begin modelling using fuzzy logic. A triangular membership function was used for the input and output parameters. Cutting speeds within the range 2000 to 3200 rpm were expressed as three fuzzy sets as shown in 8A Fig. 8(a) {low (mf1), medium (mf2), high (mf3)}, and in vector form as  $S = \{S1, S2, S3\}$ . The membership functions are shown in Fig. 8(d).

$$S_1(x) = \frac{2600-x}{600}, x \in (2000, 2600) \quad \dots (19)$$

$$S_2(x) = \begin{cases} (x - 2000)/600, & x \in (2000, 2600) \text{ \& } x \in \\ (3200 - x)/600, & (2600, 3200) \end{cases} \quad \dots (20)$$

$$S_3(x) = \frac{x-2600}{600}, x \in (2600, 3200) \quad \dots (21)$$

The fuzzy values determined the degree of membership for any object in a fuzzy set. A survey of the available literature shows no specific way of deciding the shape of membership function, so most of it was by trial-and-error methods. However, the triangular function covered all key points and hence was chosen. Using fuzzy rules was advantageous, as it considered existing expertise in the quality and effects of variables, which proved challenging when using

traditional methods. This work chose the Sugeno method to study fuzzy reasoning and inference. The first three rules written below are examples of fuzzy linguistic rules, and the rest are framed likewise.

Rule 1: If the feed is low, cutting speed is low, and depth of cut is low, then surface roughness is high.

Rule 2: If the feed is medium and cutting speed is medium, and the depth of cut is high, then surface roughness is medium.

Rule 3: If the feed is low, cutting speed is high, and depth of cut is medium, then surface roughness is low.

Experimental results were used to frame the rules shown in the rule editor of the fuzzy logic toolbox, as shown in Fig. 8(a). A fuzzy output set was produced from fuzzy inferences, and every control task indicated crisp values in the fuzzy controller output. Defuzzification is the process of extracting these crisp values, and though there are many methods available, the Singleton method was used to predict optimal output parameters. The MATLAB Fuzzy Logic toolbox was used to carry out this process.

Figure 8(b) represents the fuzzy logic reasoning process from Taguchi's  $L_9$  experiments, where rows represent nine rules, four columns represent the three inputs (shown by the triangles' locations), and one output parameter (shown by the thick, vertical single lines). The shaded area of a triangle represents fuzzy membership values for that particular fuzzy set. From

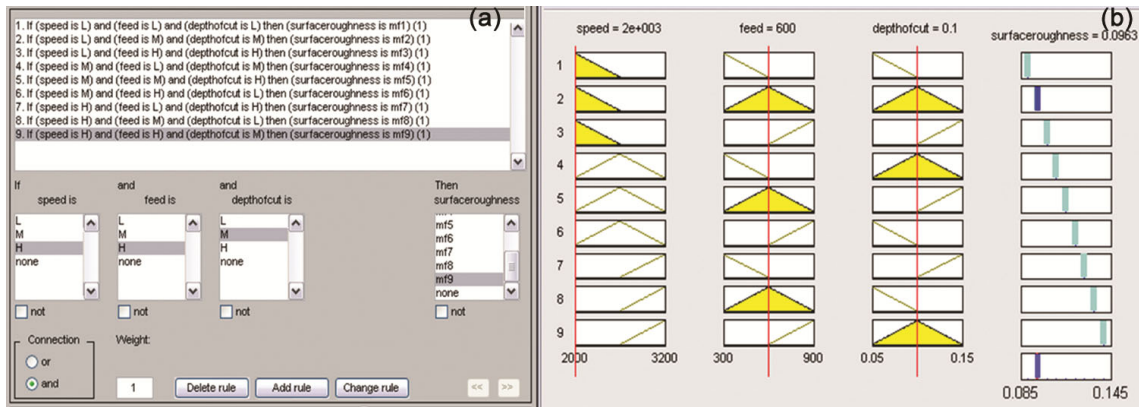

Fig. 8 — (a) ANFIS Sugeno type rule editor, and (b) Fuzzy logic reasoning results for CNT-CBN wheel.

the defuzzified output, calculated as the sum of all triangular areas in the last column, the surface roughness had a value of  $0.0963 \mu\text{m}$ .

Validation was done by comparing experimental results with those obtained from the Sugeno model. The optimum combination of parameters minimising surface roughness for the CNT grinding wheel was identified. Results from MATLAB showed that when feed was low and cutting speed was high, surface roughness was optimum. Twenty validation runs were carried out for the ANFIS results, and the predicted values were less than 5% different from the experimental results.

The following steps were required in the ANFIS problem:

- Design of the hybrid model using a Sugeno-type fuzzy inference engine.
- Optimisation of the FIS model, given an authentic classification
- Setup of input process parameters to compose training and testing data matrices.
- Execution of ANFIS hybrid algorithm using the training data.
- Cross-checking and testing of the model using 10% testing data

The ANFIS model with three input parameters has its triangular membership function with high, medium and low values. 9 fuzzy rules were then framed in the Sugeno type Fuzzy inference system to produce nine outputs with singleton membership functions.

### 3.7 ANFIS Training model for grinding with CNT-CBN grinding wheel

The ANFIS model for the CNT-CBN grinding wheel was developed in terms of grinding parameters

to predict surface roughness. Surface roughness data was used to train the system, and experimental validation runs were completed to validate the model. Percentage deviation was used to judge the accuracy and ability of the model. This process has been explained below.

For grinding with CNT-CBN wheels, the surface roughness values of Ti-6Al-4V were taken as input training data, and 100 epochs were selected. The training error remained constant, as shown in Fig. 9(a).

As shown in Fig. 9(b), the training data with singleton FIS output from Sugeno type FIS editor was used to train, which fit well with zero error. The regression model data shown in Fig. 9(c) were taken for testing with the FIS output for the CNT-CBN grinding wheel. The regression model values were taken for checking. Regression checking data with FIS output for grinding with the CNT-CBN wheel has been shown in Fig. 10.

For grinding with a CNT-CBN wheel, the blue points (+) in Fig. 10 show data before training from experimental values, and the red data points (\*), the regression data after training by the ANFIS model. The average testing error was 0.0046034 from that predicted by the ANFIS model. From this very-low error value, it was seen that the adaptive fuzzy inference system is quite precise and accurate. With CNT-CBN grinding, the average testing error was lesser than that of the CBN grinding wheel.

Figure 11(a&b) represented surface roughness predictions from the model developed using ANFIS, a function of values determined experimentally. It is to be noted that the data set for tests were not introduced to ANFIS during training and the straight-line drawn showed perfectly predicted values. For Ti-6Al-4V



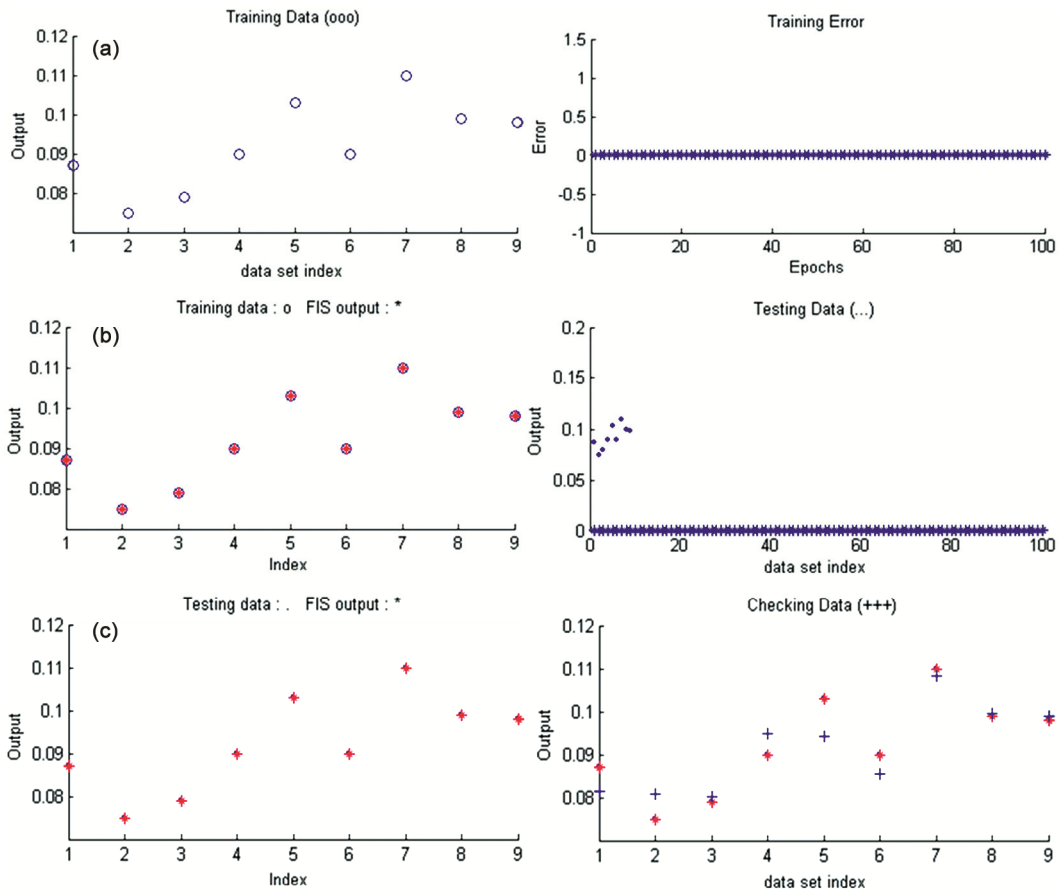

Fig. 9 — (a) Initial, experimental, training data with training error for grinding with CNT-CBN wheel, (b) ANFIS training data with FIS output for grinding with CNT-CBN wheel, and (c) ANFIS testing data with FIS output for grinding with CNT-CBN wheel.

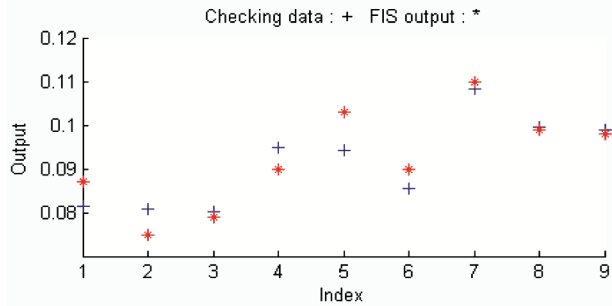

Fig. 10 — Regression checking data with FIS output for grinding with CNT grinding wheel.

work pieces ground with a CNT-CBN grinding wheel, the mean testing error was 0.0046, and the correlation coefficient was 0.997 as shown in Fig. 11(a). The CBN grinding wheel’s testing error was 0.0098, and the correlation coefficient was 0.889, as shown in Fig. 11(b). It compared these ANFIS models, and a high  $R^2$  value for grinding with CNT with CBN showed that the experimental model fit well with the predicted model.

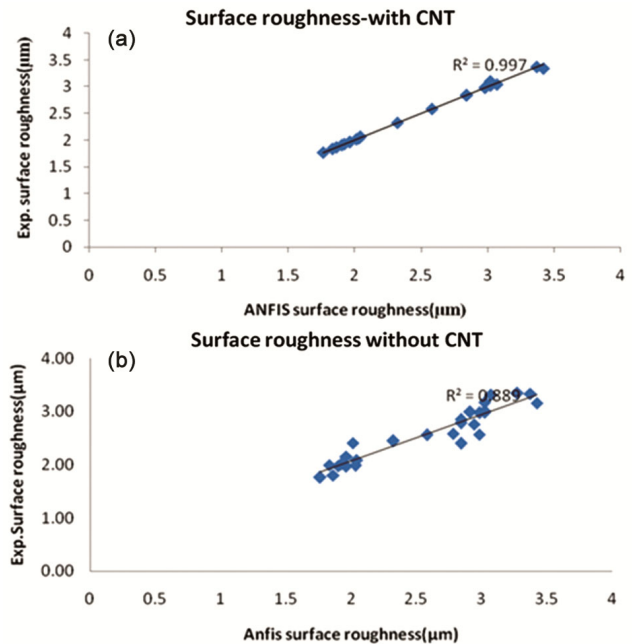

Fig. 11 — (a) Surface roughness predictions from experimental values with CNT-CBN wheel, and (b) CBN grinding wheel.

#### 4 Conclusions

The ANFIS modelling was done to predict surface roughness values for CNT-CBN grinding wheel on Ti-6Al-4V material.

- a) ANFIS model-generated results were almost identical to experimental values, with 99.7% data accuracy. The regression model was used to compare predicted values with experimental grinding values. Using CNT incorporated grinding wheel, the  $R^2$  value obtained was 0.9327 compared with CBN based grinding process value, which was 0.920. The predicted model fits well, as seen from the high experimental  $R^2$  values.
- b) The predicted surface roughness for the Taguchi method with CNT grinding wheel was 0.086  $\mu\text{m}$ , and for ANFIS fuzzy model, 0.0963  $\mu\text{m}$ . The average testing error was 0.0098216, which is very small, and the error predicted by the ANFIS model was precise. This small error shows the efficiency of the ANFIS model.
- c) The Sensitivity analysis showed that the cutting speed of the CBN grinding wheel was less negatively influenced when compared with the depth of cut, which showed a more significant negative influence on surface roughness for a wide range of sensitivity analyses.
- d) SEM analysis showed that work pieces ground with CNT grinding wheel exhibited fewer micro-cracks or pits. The wheel also displayed the uniform homogeneous distribution of CNT on the surface. The CBN grinding wheel showed more dislodgement of particles and non-uniform adhesion of the CBN particles. Improper adhesion led to less heat absorption and release into the environment.
- e) Results from this study portray that ANFIS can be used to optimise the grinding process and may apply to other manufacturing processes. Using this, an engineer would quickly have ways and means for intelligent online control and optimisation. This system can be used as an alternative to conventional modelling techniques, as it is easy to understand and straightforward.

#### References

- 1 Jesuthanam C P, Kumanan S & Asokan P, *Mach Sci Technol*, 11(2) (2007) 271.
- 2 Hashmi K, Graham I D, Mills B & Hashmi M S J, *J Mater Process Technol*, 142 (1)(2003) 152.
- 3 Prabhu S, Uma M & Vinayagam B K, *Neural Comput Appl*, 26 (1) (2014) 41.
- 4 Dao T P, *Math Probl Eng*, (2016).
- 5 Li Y, Shieh M D, Yang C C & Zhu L, *Math Probl Eng*, (2018).
- 6 Chau N Le, Dao T P & Nguyen V T T, *Math Probl Eng*, (2018).
- 7 Pandiyan V, Caesarendra W, Glowacz A. & Tjahjowidodo T, *Symmetry (Basel)*, 12(1)(2020).
- 8 Baraheni M, Azarhoushang B, Daneshi A, Kadivar M & Amini S, *Int J Adv Manuf Technol*, (2021) 2823.
- 9 Baseri H & Alinejad G, *World Acad Sci Eng Technol*, 73(1) (2011) 499.
- 10 Baseri H, *Int J Abras Technol*, 3(4) (2010) 316.
- 11 Dambatta Y S, Sayuti M, Sarhan A A D, Ab Shukor H Bin, Derahman N A binti & Manladan S M, *Ind Lubr Tribo*, 71(2) (2019) 309.
- 12 Mamalis A G, Vogtländer L O G & Markopoulos A, *Precis Eng*, 28(1) (2004) 16.
- 13 You Jiali, *Carbon Nanotube Grinding Wheel for Nano Machining of Engineering and Biomedical Materials*, PhD thesis, Hong Kong University of Science and Technology, 2009.
- 14 Bakshi S R & Agarwal A, *Carbon*, 49(2) (2011) 533.
- 15 Bansal S, Kumar N & Jindal P, *Mater Today Proc*, 4(2) (2017), 3867.
- 16 [https://www.predev.com/pdf/files/surface\\_roughness\\_terminology\\_and\\_parameters.pdf](https://www.predev.com/pdf/files/surface_roughness_terminology_and_parameters.pdf) (18 May 2020).