



Performance Analysis of Bi-directional Optical Network Using Hybrid Optical Amplifier in the Context of Multiplay Services

Parashuram^a, Chakresh Kumar^{a*} & Ghanendra Kumar^b

^aUniversity School of Information, Communication & Technology, Guru Gobind Singh Indraprastha University, New Delhi-110 078, India

^bDepartment of Electronics and Communication Engineering, National Institute of Technology, Delhi-110 040, India

Received 19 November 2021; accepted 31 December 2021

Performance of bi-directional optical network has evaluated for 400 optical network units (ONUs) using RAMAN-EDFA hybrid optical amplifier (HOA). Further, performances have also recorded in terms of quality factor and eye height for the data rate of 5 Gbps, 10 Gbps, 15 Gbps, 20 Gbps and 25 Gbps respectively for the distance of 60 km to 75 km. Limits of the users have also set to 400 for the analysis of various aspects for multiplay services (data, voice, video and mobile service). Data rate of 5 Gbps has delivered the acceptable outcome for multiplay services (MPS). Furthermore, proposed super dense passive optical network (SD-PON) has also shown the stability among the present current research of art in terms of acceptable rating outcome.

Keywords: Hybrid optical amplifier (HOA); Quality factor; Eye height; Multiplay services; Bi-directional optical network

1 Introduction

Due to revolutionary changes in optical communication industry, requirement of best services with high-speed network, develops the new innovative models for enhancing the existing network capacity. Multiplay services (MPS) are the right business model for the network provider. Data, voice, video services and mobile services are the main parts of MPS¹. Requirement of high-capacity network has been justified by super dense multiplexing technology. But it deals with lot of complex modifications in the existing technology.

Major issues are reflected for the best communication technology in terms of huge bandwidth, high speed network, cost and environments of subscribers.

Demand of huge bandwidth services such as definition television (HDTV) has been observed for high broadband access network so super dense wavelength division multiplexing passive optical network (SD-WDMPON) is the most acceptable architecture for proving best rating services in required manner^{2,3}.

Tremendous growth in optical communication network in terms of high bandwidth, high speed internet and controlling data traffic can only be possible with direct modulation for super wavelength

dense multiplexing (SD-WDM) system with cost-effective manner⁴⁻⁷.

A super dense passive optical network (SD-PON) is the rapid growing technology for providing the MPS service such as data, voice, video services and mobile services in terms of best rating quality factor and eye height from service provider to end users in FTTC, FTTB and FTTH access networks⁸⁻¹⁰.

In fact, high-capacity services such as video conferencing, high-capacity internet, video on demands and online gaming service accelerate the service provider to deliver the services in cost effective manner with best rating outcome. Whereas, SD-PON with hybrid optical amplifier (HOA) is the most promising technology for integrated access network such as fiber to the home (FTTH), fiber to the curb (FTTC) and fiber to the building (FTTB) for required outcome with cost effective manner¹¹⁻¹².

So far, many advance technologies have been investigated in the existing literature to enhance the transmission process for multiplay service.

Goyal *et al.*¹³ investigated the performance of hybrid wavelength passive optical network with 128 ONUs in terms of multiplay service for the range of 1480 nm to 1500 nm with data rate of 1.25 Gbps with successful transmission of 28 km.

Son *et al.*¹⁴ observed the performance of bi-directional passive optical network for wavelength

*Corresponding author: (E-mail: chakreshk@ipu.ac.in)

division multiplex (WDM) system. Capacity of channel was set to 15 for downstream and upstream with data rate of 155 Mbps to 2.5 Gbps.

Kocher *et al.*¹⁵ explored the performance of FTTH architecture for downstream and upstream channels and performances have been investigated in the context of different data rate. Furthermore, data rate at 10 Gbps deliver the error free performance for 64 ONUs.

Akanbi *et al.*¹⁶ investigated a bidirectional super dense system with 32 channels. Data rate of 10 Gbps has been mentioned the best rating outcome in terms of error free transmission of 20 km. Malhotra *et al.*¹⁷ explored the performance of 32 channels FTTH network. Further, performances have been evaluated in terms of bit error rate, quality factor and eye-opening etc. Data speed has set to 2.5 Gbps. Kocher *et al.*¹⁸ investigated the multiplay service for passive optical network for 56 users at 20 km distance. Further, performances have been evaluated in terms of BER with data rate of 2 Gbps.

Up to now, from the different literatures, it has been observed that distance of proposed passive

optical network (PON) has been set to less than 80 km with less data rate of 2.4 Gbps. Furthermore, effect of hybrid optical amplifier (HOA) has not been mentioned for huge capacity data transmission which is an important consideration for best rating features. Further, these proposed models were only capable for downlink transmission with a smaller number of ONUs¹³⁻¹⁹.

In this paper we have rectify the main affected feature to enhance the performance of bi-directional optical network with the support of HOA for super dense optical network unit (ONU) for best rating data rate.

However, the arrangement of this paper is given as description of proposed simulation setup in section II, discussion on final result with analysis in section III and conclusion is made with systematic manner in section IV.

2 Description of Proposed Simulation Setup

Simulation setup for bi-directional optical network for 400 ONUs is shown in Fig. 1(a). Voice and mobile services are generated from data source, NRZ electrical drive, frequency modulator (FM) and sine

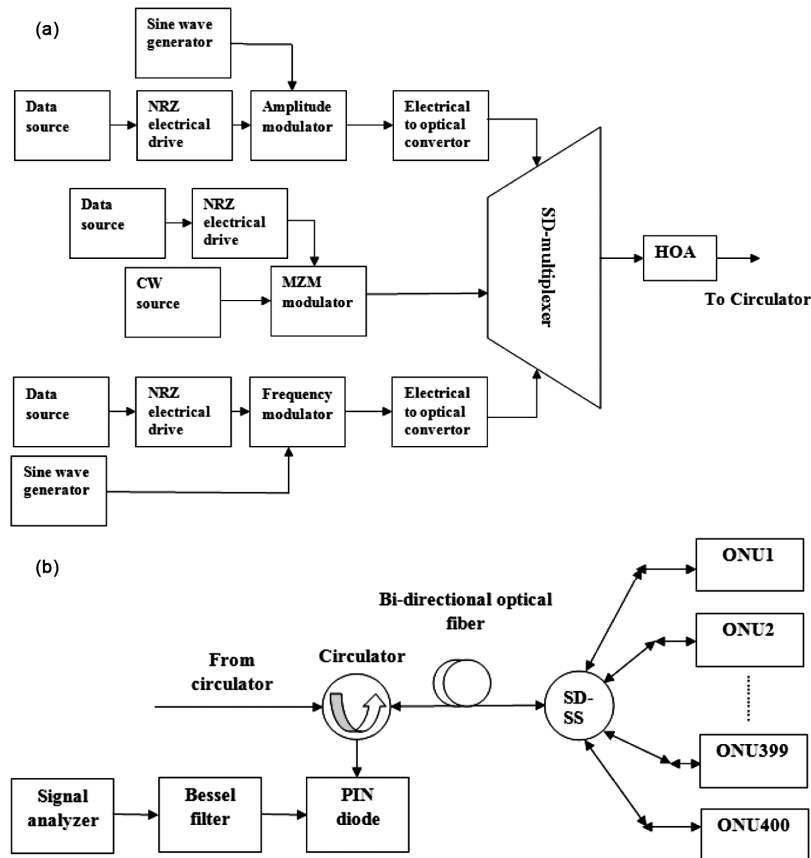

Fig.1 — Simulation setup for bi-directional multiplex services.

wave generator. Varying data rate from 5 Gbps to 25 Gbps is connected to electrical drive to generate the electrical signal which is followed by FM to generate the modulated signal for down traffic transmission.

Electrical to optical (E/O) converter is placed after the modulated signal with gain of 25 dB for the further amplification process.

For generation of data services, input power of CW source is set to -15 dBm with 20 dB extinction ratio. Range of CW laser source is arranged from 1530 nm to 1565 nm as a downstream wavelength. Data source with PRBS generator is set with varying data rate. NRZ electric drive converts these pulse bits in respective electrical signals which further followed by MZM modulator to boost the level of low power signal to high power signal.

To generate the video signal, sine wave generator is set to 20 GHz frequency with 0 phase for carrier generator at 4 Gbps. Received electrical signal in NRZ format is also injected to amplitude modulator at 2.5 GHz frequency. Modulated electrical signal is connected to (E/O) converter for further optical processing.

In this way, data, voice, video and mobile services signals are generated and combined with super dense multiplexer (SD-M) with guard band to tolerate the effect of inter-symbol-interference (ISI). A pre-RAMAN-EDFA hybrid optical amplifier (HOA) is used before transmitting the signals for further processing.

A circulator is the main device to perform the bi-directional operation. It is adjusted with 3.5 insertion loss. A delay element is arranged to maintain the least effect of dispersion and ISI. Received data from optical line termination (OLT) for upstream is further analyzed with PIN photo diode with 1 A/W responsivity and dark current of 15 nA, Bessel filter has 0.80 x bit rate as simulated frequency and signal analyzer is shown in Fig.1(b). A bi-directional optical fiber is placed to communicate the signals among 400 users which is only possible by using super dense star splitter (SD-SS). Different users are able to receive the original services by converting the optical signal to electrical signal with the help of PIN photodiode and Bessel filter.

Internal architecture of ONU is also shown in Fig. 2. Further, uplink transmission (from ONU port) set up is also given in Fig. 2(a), it consists of electrical signal, analog to digital (A/D) converter, NRZ electrical drive, DFB laser and modulator. In the similar manner, downlink signals (to ONU port) are

also received with the support of PIN photo diode, low pass filter (LPF) and signal analyzer in Fig. 2(b).

3 Discussion on Final Results and Analysis

Performances of received multiplex services are evaluated for the characteristics of quality factor and eye height from Figs. 3-10 in terms of downlink and uplink transmission.

Quality factor with respect to number of users is evaluated for varying the data rate in Fig. 3. Recorded values for downlink transmission at the distance of 60 km are given as 31.5 dB for the data rate of 5 Gbps, 26.5 dB for the data rate of 10 Gbps, 17.1 dB for the data rate of 15 Gbps, 14.3 dB for the data rate of 20 Gbps and 7.6 dB for the data rate of 25 Gbps respectively.

In the similar manner, recorded values for uplink transmission from Fig. 4 in terms of same features are given as 25.5 dB for the data rate of 5 Gbps, 21.5 dB for the data rate of 10 Gbps, 15.1 dB for the data rate of 15 Gbps, 10.2 dB for the data rate of 20 Gbps and 5.2 dB for the data rate of 25 Gbps respectively. Here, it is also analyzed from the outcome of Fig. 3 & Fig. 4

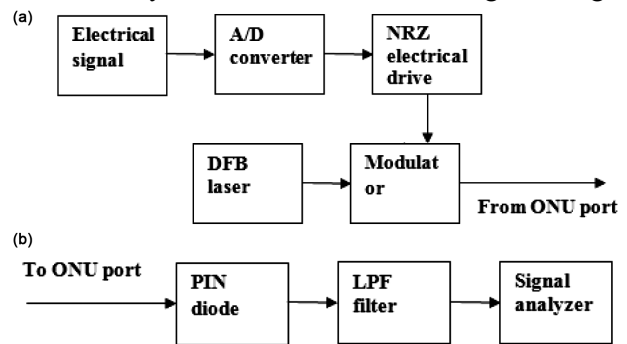

Fig. 2 — Internal architecture of optical network unit.

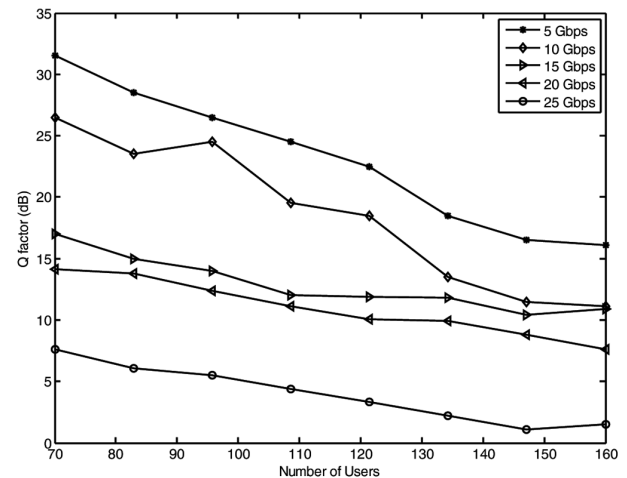

Fig. 3 — Quality factor with respect to number of users for downlink for the distance of 60 km.

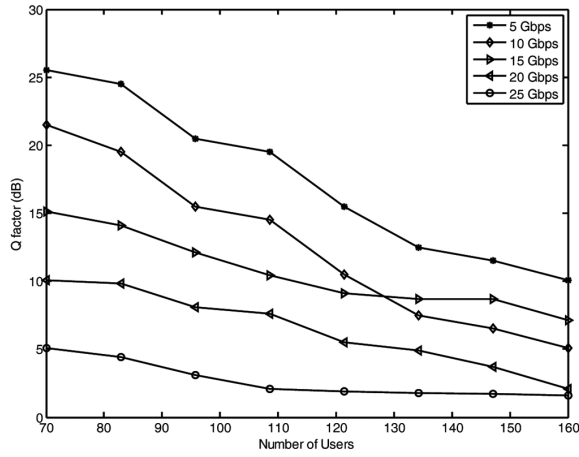

Fig. 4 — Quality factor with respect to number of users for uplink for the distance of 60 km.

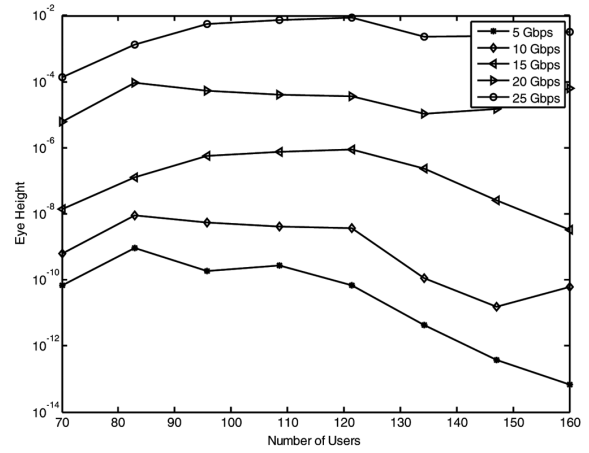

Fig. 6 — Eye height with respect to number of users for uplink for the distance of 60 km.

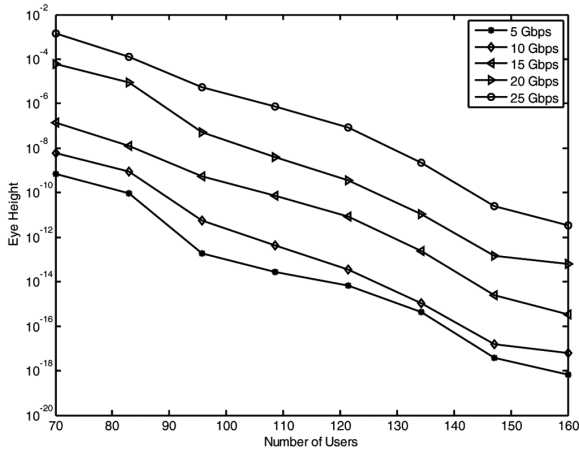

Fig. 5 — Eye height with respect to number of users for downlink for the distance of 60 km.

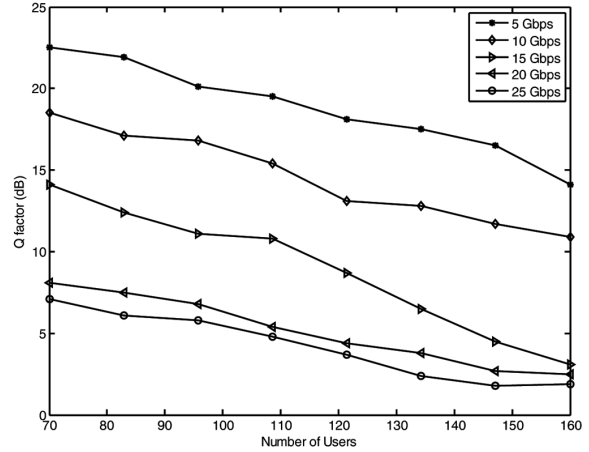

Fig. 7 — Quality factor with respect to number of users for downlink for the distance of 75 km.

that transmission data rate from 10 Gbps to 25 Gbps does not deliver the required output due to induced fiber nonlinearity and internal loss of transmitted signal subsequently, signals are degraded.

However, 5 Gbps transmission rate delivers the best rating acceptable values in the presence of stimulation amplification from RAMAN-EDFA hybrid optical amplifier (HOA).

Performances of multiplex service for 400 ONUs are also evaluated in terms of eye height with respect to number of users for the distance of 60 km in Fig. 5 and Fig. 6 for downlink and uplink transmission respectively. Recorded values are given as 6.68×10^{-10} for 5 Gbps, 6.2×10^{-9} for 10 Gbps, 1.4×10^{-7} for 15 Gbps, 6.2×10^{-5} for 20 Gbps and 1.4×10^{-3} for 25 Gbps respectively for downlink transmission.

In the similar way, recorded values from Fig. 6 for uplink transmission at the distance of 60 km are given

as 6.68×10^{-11} for 5 Gbps, 6.2×10^{-10} for 10 Gbps, 1.4×10^{-8} for 15 Gbps, 6.2×10^{-6} for 20 Gbps and 1.4×10^{-4} for 25 Gbps respectively. Here, it is observed that lower value of eye height indicates the massive influence of fiber nonlinearity, dispersion and internal crosstalk. Eye height shows the inversely proportional relation with bit error rate (BER) so good rating of eye height neglected the effect of BER for delivering the best rating services to users.

Now, the performance of proposed bi-directional optical network is evaluated by considering the transmission distance up to 75 km for the same rating feature in terms of downlink and uplink transmission from Fig. 7 to Fig. 10 respectively. Observed values from Fig. 7 for downlink transmission are given as 22.5 dB for 5 Gbps, 18.5 dB for 10 Gbps, 14.1 dB for 15 Gbps, 8.1 dB for 20 Gbps and 7.1 dB for 25 Gbps respectively.

Similarly, recorded values from Fig. 8 for uplink transmission are given as 18.5 dB for 5 Gbps, 14.4 dB for 10 Gbps, 10.9 dB for 15 Gbps, 9.1 dB for 20 Gbps and 5.2 dB for 25 Gbps respectively. Recorded readings are reflected that effect of quality factors are degraded with increasing the data rate with same rating input power level. But it can be rectified by good rating HOA.

Variations in eye height for downlink transmission at the distance of 75 km is shown in Fig. 9. Observed values are given as 6.68×10^{-8} for 5 Gbps, 6.2×10^{-10} for 10 Gbps, 1.2×10^{-6} for 15 Gbps, 5.1×10^{-5} for 20 Gbps and 1.2×10^{-2} for 25 Gbps respectively.

Similarly, from Fig. 10, recorded values for uplink transmission are given as 6.68×10^{-5} for 5 Gbps, 6.2×10^{-6} for 10 Gbps, 1.2×10^{-9} for 15 Gbps, 5.1×10^{-4} for 20 Gbps and 1.2×10^{-1} for 25 Gbps respectively.

Received results are indicated that measuring parameters such as quality factor and eye height are degraded due to height bit rate. It means at 10 Gbps, 15 Gbps, 20 Gbps and 25 Gbps. But data rate at 5

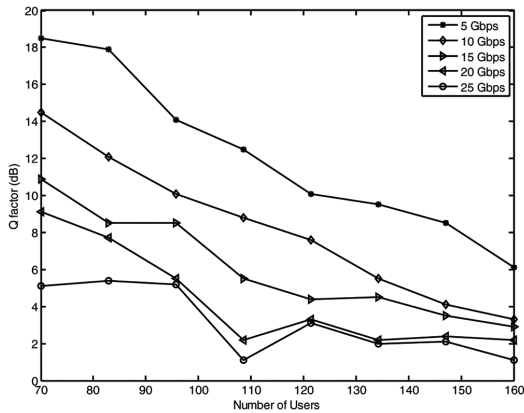

Fig. 8 — Quality factor with respect to number of users for uplink for the distance of 75 km.

Gbps is capable to maintain the required rating for recommended users using HOA.

Furthermore, eye diagrams for downlink and uplink transmission for the distance of 75 km are shown in Fig. 11 for the data rate of 5 Gbps.

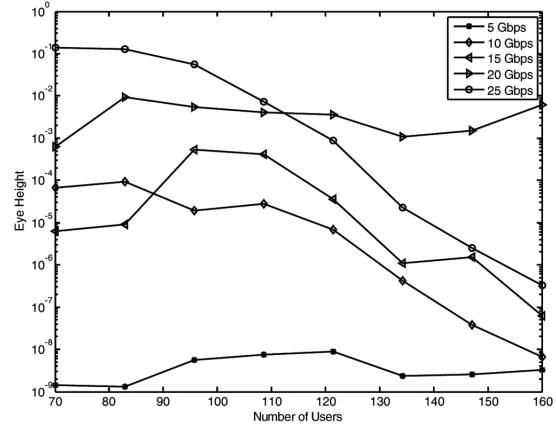

Fig. 10 — Eye height with respect to number of users for uplink for the distance of 75 km.

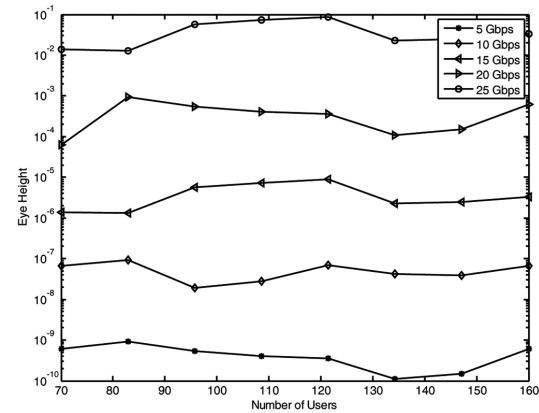

Fig. 9 — Eye height with respect to number of users for downlink for the distance of 75 km.

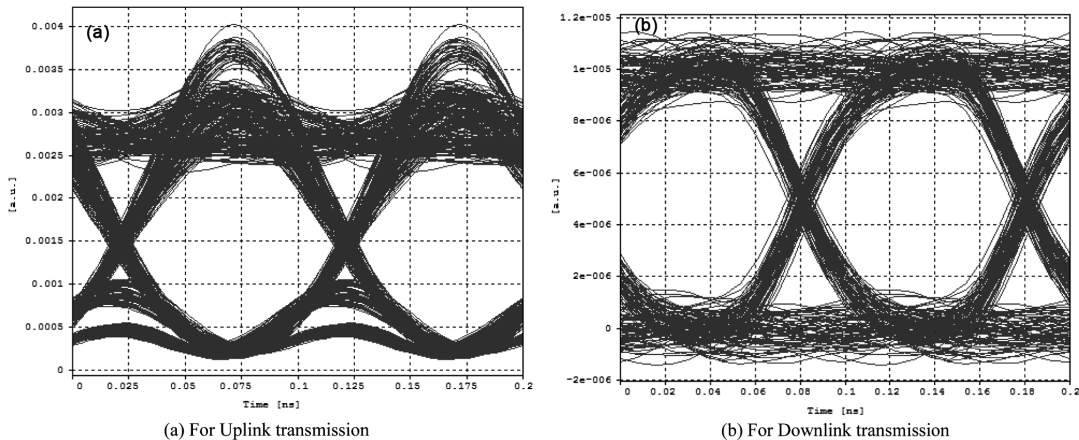

Fig. 11 — Eye diagram for uplink and downlink transmission at the distance of 75 km.

Table 1 — Comparison of proposed model with current research of art schemes

Parameters	Malhotra et al. ¹⁷	Singh et al. ¹⁹	Kocher et al. ¹⁵	Goyal et al. ¹³	Kumar et al. ²⁰	Kumar et al. ²¹	Proposed model
Multiplay services	No	No	No	No	No	No	Yes
System cost	High	Low	High	High	Low	Low	No
Transmission with HOA	No	No	No	No	No	No	Yes
No. of users	32	128	64	128	200	160	400
Data rate	2.5 Gbps	10 Gbps	10 Gbps	1.25 Gbps	2 Gbps	4 Gbps	5 Gbps
Transmission distance	100 km	40 km	50 km	28 km	30 km	35 km	60 km
Transmission mode	Single directional	Bi-directional	Bi-directional	Single directional	Single directional	Single directional	Bi-directional

4 Conclusion

Performances of bi-directional optical network for 400 ONUs with HOA has done for the features of quality factor and eye height for the data rate of 5 Gbps to 25 Gbps. Effect of nonlinearity, dispersion and amplified spontaneous emission (ASE) noise have degraded the performance of optical signal due to insufficient input power. But it can also be adjusted with the support of best rating HOA. Data rate of 5 Gbps delivers the acceptable outcome for the recommended users in the context of multiplay services. With comparison of current research of art in Table-1, it is reflected that our proposed model is accomplished the best rating outcome for bi-directional optical network without using any cost influence techniques. Further, final analysis is also recommended to commercial network operator to enhance the multiplay services for super dense network using the HOA.

References

- 1 Park S J & Lee C H, *J Light Wave Technol*, 22 (2004) 12.
- 2 Przyrembel G & Kuhlrow B, *Conf Opt Opt Fiber Commun*, 1 (1999) 207.
- 3 Frigo N J, Reichmann K C, Iannone P P, Zyskind J L, Sulhoff J W & Wolf C, *Conf Opt Fiber Commun*, 16 (1997) 24.
- 4 Morgado J, Fonseca D & Cartaxo A, *Opt Express*, 19 (2019) 23.
- 5 Gamage P, Nirmalathas A, Lim C, Wong E, Novak D & Waterhouse R, *IEEE Photon Technol Lett*, 20 (2008) 24.
- 6 Yeh C, Chow C, Chen H, & Sung J, *Electron Lett*, 48 (2012) 7.
- 7 Quinlan T, Dudley S, Morant M, Llorente R & Walker S, *Opt Express*, 20 (2012) 16726.
- 8 Morant M, Llorente R, Herrera J, Alves T, Cartaxo A & Herman M, *IEEE Photon Technol Lett*, 26 (2014) 8.
- 9 Romero R, Zhao R & Machuca C, *IEEE Commun Mag*, 52 (2014) 77.
- 10 Farmer J O, *ICCE Int Conf*, 185 (2002) 159.
- 11 Fady I, Nahal E, Hakeim A & Husein M, *Optik*, 122 (2011) 1776.
- 12 Ma X, Gann C, & Deng S, *Opt Switch Netw*, 10 (2013) 100.
- 13 Goyal R & Kaler R, *Opt Fiber Technol*, 18 (2012) 518.
- 14 Son E S, Han K H, Kim J K & Chung Y C, *IEEE J Lightwave Technol*, 21 (2003) 8.
- 15 Kocher D & Kaler R S, Randhawa R, *Optik*, 124 (2013) 5075.
- 16 Akanbi O, Jianjun Y & Chang G K, *IEEE Photon Technol Lett*, 18 (2006) 340.
- 17 Malhotra J S, Kumar M, & Sharma A K, *Optik*, 124 (2013) 2424.
- 18 Kocher D, Kaler R S & Randhawa R, *Optik*, 121 (2013) 5007.
- 19 Singh S, *Int J Light Electron Opt*, 125 (2014) 5837.
- 20 Kumar G & Kumar S, *Photon Netw Commun*, 39 (2020) 232.
- 21 Kumar G & Kumar S, *Natl Acad Sci Lett*, 44 (2021) 415.