

Study of Dielectric Relaxation and Hydrogen Bonding Interaction of 1, 4-Butanediol-1, 4-Dioxane Mixture using TDR Technique

Nitin P Garad, Shankar H Sakhure, Ashwini G Gubre & Ashok C Kumbharkhane*

School of Physical Sciences, Swami Ramanand Teerth Marathwada University, Nanded, Maharashtra 431 606, India

Received 2 January 2023; accepted 27 February 2023

The complex permittivity spectra of 1, 4-butanediol -1, 4-dioxane binary mixtures have been measured in the frequency range from 10MHz to 30GHz using the time domain reflectometry (TDR) technique. The complex permittivity spectra show the Cole-Davidson type relaxation. The static dielectric constant and relaxation time at various temperatures have been obtained from complex permittivity spectra by using the nonlinear least squares fit method. The orientation of electric dipoles and solute-solvent interaction in the liquid mixture was confirmed from the excess, Bruggeman, Kirkwood correlation factor and thermodynamic parameters.

Keywords: Complex permittivity spectra; TDR; Dielectric constant; Relaxation time; Kirkwood correlation factor; Thermodynamic parameters

1 Introduction

Time domain reflectometry (TDR) is one of the experimental technique used for accurate measurements of the complex dielectric permittivity $\epsilon^*(\omega)$ over a broad frequency range. Understanding the structure of liquids from experimental data and developing liquid molecular model are important and challenging. Recently extensive experimental investigation on the relationship between dielectric relaxation and the -OH group has been done on polyhydric alcohols (diol's)¹⁻⁴. The dielectric, spectroscopic, structural and dynamical properties have all been investigated¹⁻⁵. In general, data reported from various techniques and physical approaches are used to investigate the molecular structure of liquids¹⁻⁵. Polyhydric alcohols are of particular interest among liquids with hydrogen bonds because of their tendency to form strong hydrogen bonds with the other molecules and the existence of numerous OH groups⁶.

Organic compound alcohol are extensively utilized chemicals in industry and technology for a variety of applications⁷ such as a reagent, solvents or chemical intermediates⁸ and exhibit a number of conformational characteristics due to their molecular flexibility⁹. The organic compound diol with structural formula $\text{OHCH}_2\text{CH}_2\text{CH}_2\text{CH}_2\text{OH}$ is 1, 4-butanediol (1,4BD), this colorless viscous liquid is

derived from butane where hydroxyl groups present at the first and last carbon of the chain³. It is used in industry as a solvent and in the production of certain types of polymers, elastic fibers, and polyurethane chain extenders. The butanediol have several uses in biochemical research, particularly in the cryopreservation of living organs.

The 1, 4-dioxane (DX) is a heterocyclic diethyl ether, and each of its two oxygen atoms forms an ether functional group. It is a common example of non-polar, non-ionic liquid. Its structure includes ether oxygen, an H-bond acceptor site, and hydrophobic ($-\text{C}_2\text{H}_4$) non-interacting sites. Due to absence of H-bond donor sites DX is non-associative, however it would be fascinating to investigate its properties in the presence of associating liquids¹⁰. In the past butanediols have been extensively studied in the presence of polar and non-polar solvent at room temperature and above^{1,3,9,11,12}. This investigation is mainly carried out on the hydrogen bonding interaction and dipole orientation in presence of non polar solvent and their effects on the thermodynamical properties bellow room temperature.

This work reports the dielectric relaxation behaviour of 1,4BD in the solvent 1,4DX using time domain reflectometry technique (TDR) at various temperatures in the frequency range from 10MHz to 30GHz. These investigations aimed to understand the role of 1,4-dioxane molecules in the structure of 1,4-

*Corresponding authors: (E-mail: akumbharkhane@yahoo.co.in)

butanediol and their effects on hydrogen bonding and dipole orientation. The dielectric parameters such as dielectric constant, relaxation time, Bruggeman factor, excess dielectric properties, thermodynamic parameters, Kirkwood correlation factor for 1,4BD in 1,4DX solutions have been evaluated. The dielectric parameters help to understand the molecular interaction correlation and hydrogen bonding in between solute and solvent molecules.

2 Experimental

2.1 Materials

The chemical 1,4BD purchased from MERCK SPECIALITIES PVT. LTD. and 1,4DX from SIGMA ALDRICH CHEMICALS PVT. LTD. both are having 99% purity and used without further purification.

2.2. Measurement

Time domain reflectometry (TDR) technique was used to obtain the dielectric complex permittivity

spectra in between the frequency range from 10MHz to 30GHz. The sampling mainframe oscilloscope Tektronix digital serial analyzer DSA8300 and sampling module 80E10B were used and are shown in Fig. 1¹³. The Fourier transformation has been used to convert time domain data into frequency domain and further data analysis were done to determine complex permittivity spectra $\epsilon'(\omega)$ using least square fit method⁴. To maintain the temperature of the system constant the temperature bath along with thermometer is used with an accuracy of ± 1 °C.

3 Result and Discussion

3.1 Complex permittivity spectra

Figure 2(a) shows the complex permittivity spectra of 1,4BD-1,4DX binary system at 25 °C Fig. 2(b) shows the complex permittivity spectra of pure 1,4BD at various temperatures which represent the systematic variation in dielectric permittivity (ϵ') and

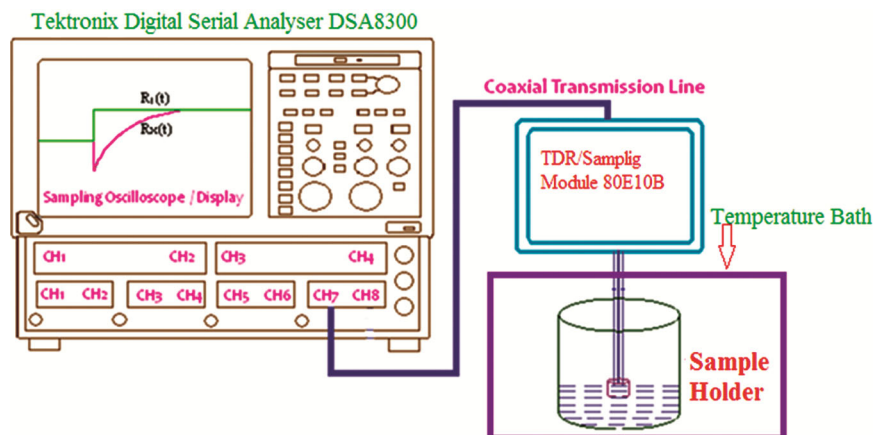

Fig. 1 — Experimental setup of time domain reflectometry.

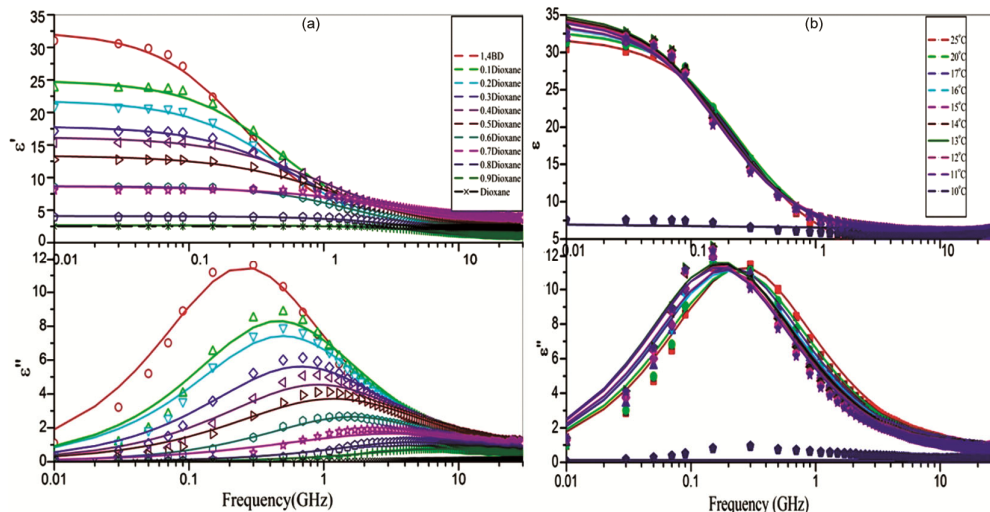

Fig. 2 — (a) Complex permittivity spectra of binary mixtures of 1, 4BD-1,4DX at 25 °C (b) Complex permittivity spectra of pure 1, 4BD at various temperatures .

Table 1 — The dielectric parameters for 1,4-butanediol-1,4-dioxane mixture at various temperature.

Vol. frac. of Dx	1,4-Butanediol-1,4-Dioxane							
	25 °C		20 °C		15 °C		10 °C	
	ϵ_s	τ (ps)	ϵ_s	τ (ps)	ϵ_s	τ (ps)	ϵ_s	τ (ps)
0	32.60(9)	616.7(52)	33.17(10)	702.1(64)	34.44(10)	845.2(77)	10.53(20)	1068.8(47)
0.1	25.02(8)	344.5(36)	26.18(8)	412.1(43)	28.78(8)	562.6 (51)	31.26(8)	782.6(66)
0.2	21.95(7)	320.9(34)	22.31(5)	408.3(31)	23.30(5)	479.6(34)	24.59(7)	551.2(49)
0.3	17.96(6)	236.2(27)	18.46(5)	278.7(27)	19.09(5)	312.6(28)	19.68(5)	343.7(33)
0.4	16.26(6)	174.6(24)	16.83(5)	192.2(20)	17.68(6)	210.0(30)	19.32(9)	238.1(47)
0.5	13.30(4)	134.8(15)	13.57(3)	141.7(12)	14.06(3)	168.6(13)	16.35(4)	201.3(22)
0.6	8.73(1)	94.9(6)	9.98(2)	96.45(10)	10.54(3)	108.3(14)	10.96(7)	114.4(37)
0.7	8.70(4)	47.1(11)	9.01(4)	48.5(11)	9.33(4)	59.1(12)	9.93(4)	69.3(15)
0.8	4.08(1)	34.2(3)	4.20(1)	36.84(27)	4.64(1)	38.94(31)	5.61(1)	40.82(50)
0.9	2.66(1)	21.9(1)	3.14(1)	22.51(20)	3.98(1)	25.56(29)	4.75(1)	28.98(45)
1	2.50(3)	3.95(2)	2.52(1)	4.01(3)	2.53(2)	4.23(3)	2.55(1)	4.45(1)

Numbers in brackets denote uncertainties in the last significant digits as obtained by the least-squares method, e.g. 32.60(9) means 32.60 ± 0.09 .

dielectric losses (ϵ'') with the frequency ranging from 10MHz to 30GHz. The experimentally obtained data ϵ' and ϵ'' were fitted into the Cole-Davidson's equations by using non-linear least squares fit method to as follow^{12,14}:

$$\epsilon^*(\omega) = \epsilon_\infty + \frac{\epsilon_s - \epsilon_\infty}{[1 + (j\omega\tau)^{1-\alpha}]^\beta} \quad \dots(1)$$

Where ϵ_s is static dielectric constant, ϵ_∞ is high frequency dielectric constant, α and β are distribution parameters and their values lies in between 0 to 1. The dielectric parameters such as static dielectric constant (ϵ_s) and relaxation time (τ) are reported in Table. 1 and are in good agreement with those reported in literature^{1,3,9,11,12}.

3.2 Static dielectric constant and relaxation time

The dielectric permittivity of liquids is affected by many factors, including temperature, the type of intermolecular forces, dipole moment, the angular correlation of a dipole with a neighboring dipole, and the number of carbon atoms present inside the molecule¹⁵. Fig. 3 shows that the mixtures dielectric constant decreases with increasing dioxane concentration for all binary combinations and temperature under study except for pure butanediol bellow 15 °C. This represents a decrease in the density of electric dipoles inside the mixture¹⁶. The decrease in dielectric constant with V_{Dx} in the mixture is also due to the transformation of more elongated aggregate molecular structure into spherical aggregate molecular structure¹⁵. The decrease in ϵ_s with respect to temperature rises is due to the orientation polarization and electric dipole alignment in the mixture¹⁷. The

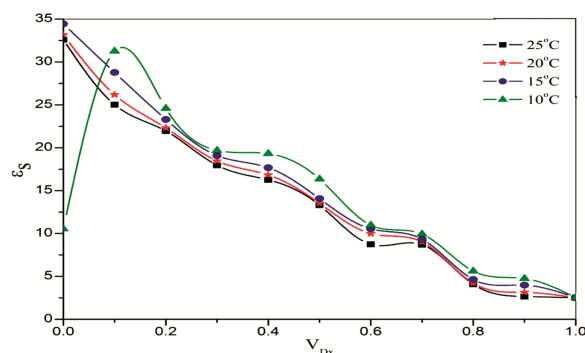

Fig. 3 — Static dielectric constant vs volume fraction of dioxane for 1, 4BD-1,4DX system.

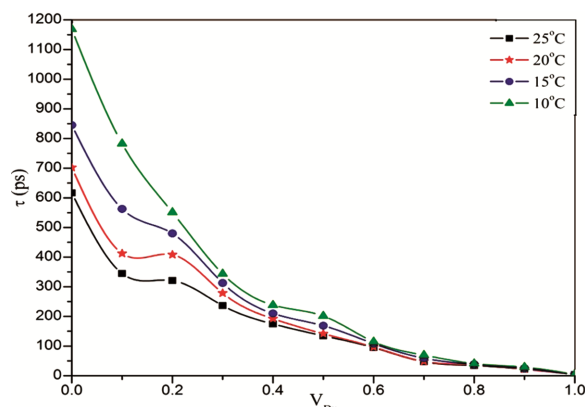

Fig. 4 — Relaxation time vs volume fraction of dioxane for 1, 4BD-1,4DX system.

pure 1, 4-Butanediols solidification takes place bellow 15 °C, according to Curme and Johnston (1953)¹⁸. Hence there are decrees in dielectric constant bellow 15 °C. The relaxation time of molecule is depends on their molecular size, functional group and viscosity of the molecules. Fig. 4 shows the plot of dielectric

relaxation time versus the V_{Dx} for binary mixtures of 1, 4BD-1,4-Dx at various temperatures. As the concentration of Dx in mixture increased, the relaxation time decreases, this suggests that a dynamic shift occurred in the structure of diol as a result of the establishment of an H-bonding interaction in between the molecules of diol and dioxane. It is also observed that the relaxation time values decreased rapidly in between the 0 to 0.7 Dx concentrations. Furthermore, as temperature increases, the strength of the intermolecular H-bond interaction decreases, enabling faster molecular rotation. This results in a decrease in relaxation time for 1, 4BD-1,4-Dx binary mixtures.

3.3 Excess properties

The excess inverse relaxation time value provides the information about the molecular rotation and interaction in binary mixtures. Excess inverse relaxation time $(1/\tau)^E$ is as follow¹⁹:

$$(1/\tau)^E = (1/\tau)_M - [(1/\tau)_{Dx} V_{Dx} + (1/\tau)_{BD} (1 - V_{Dx})] \dots(2)$$

The $(1/\tau)^E$ provides the following information about the dynamics of solute and solvent interaction:

- a) If $(1/\tau)^E = 0$, there has been no modification to the molecular dynamics.
- b) If $(1/\tau)^E < 0$, it means that the electric field created by the interaction of the solute and solvent causes the effective dipole to rotate slowly.
- c) If $(1/\tau)^E > 0$, it means that the solute and solvent interaction creates an electric field that causes the effective dipole to rotate quickly.

Eq. 2 is used to calculate the excess inverse dielectric relaxation time with Dx volume fraction at different temperatures. It can be seen from Fig. 5 that the calculated $(1/\tau)^E$ values are negative, which suggest that the solute and solvent interaction produces an electric field that causes the effective

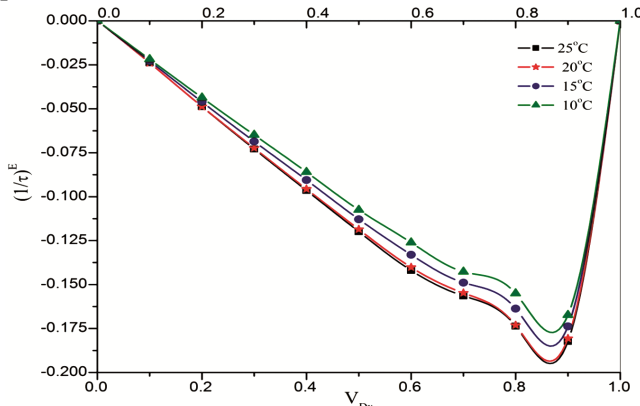

Fig. 5 — Excess inverse relaxation time vs volume fraction of dioxane for 1, 4BD-1,4DX system

dipole to rotate slowly. The peak value of the excess inverse relaxation time found at around 0.9 volume fraction of dioxane.

3.4 Bruggeman Factor (f_B)

The Bruggeman factor (f_B) provides the information regarding the static dielectric permittivity of a binary mixture by using the following equation²⁰:

$$f_B = \left(\frac{\epsilon_{sm} - \epsilon_{Dx}}{\epsilon_{BD} - \epsilon_{Dx}} \right) \left(\frac{\epsilon_{BD}}{\epsilon_{sm}} \right)^{1/3} = 1 - V_{Dx} \dots(3)$$

Where V_{Dx} is the volume fraction of dioxane and ϵ_{Dx} , ϵ_{BD} , and ϵ_{sm} are the static dielectric constants of 1,4-Dx, 1,4-BD and the mixture, respectively. A linear relationship is expected from above equation for a plot of (f_B) vs (V_{Dx}) as shown in Fig. 6 (black solid line). It can be seen that the experimental dielectric data does not follow the Bruggemans linear relationship (red points). To explain the non-linear behaviour the Bruggeman equation is modified as follow²¹:

$$f_B = \left(\frac{\epsilon_{sm} - \epsilon_{Dx}}{\epsilon_{BD} - \epsilon_{Dx}} \right) \left(\frac{\epsilon_{BD}}{\epsilon_{sm}} \right)^{1/3} = 1 - [a - (a - 1) V_{Dx}] V_{Dx} \dots(4)$$

In this equation, V_{Dx} is replaced by a factor $[a - (a - 1) V_{Dx}]$ of mixture, where "a" is arbitrary parameter. If the value of $a = 1$ corresponds to Bruggeman equation that indicate no interaction in between solute and solvent. The value of "a" is calculated at 25 °C, by using the least square fit method, and it found to be 1.24.

3.5 Thermodynamic Parameters

The Eyring rate equation is used to compute the reorientational thermodynamic parameters of a binary

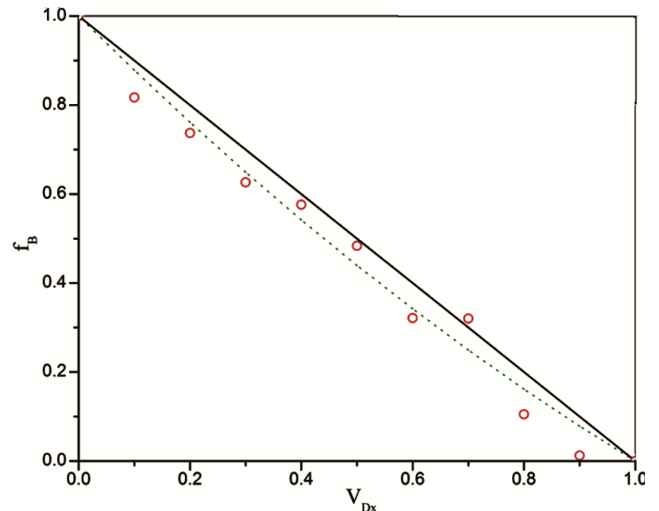

Fig. 6 — Bruggeman factor vs volume fraction of dioxane for 1, 4BD-1,4DX system at 25 °C.

mixture for different volume fractions, such as activation energy enthalpy ΔH , and entropy ΔS ²².

$$\tau = \frac{h}{kT} \exp \frac{\Delta H - T\Delta S}{RT} \quad \dots(5)$$

Where τ , k , R , h , T denote the relaxation time, Boltzmann constant, gas constant, Planck's constant, and Temperature respectively. In order to determine activation energy the slope and intercept of $\log(T*\tau)$ versus $1000/T$ have been used as shown in Fig. 7. The molar enthalpy of activation (ΔH) is positive and fluctuating for different concentrations as shown in Fig. 8, which indicate that during the dipole reorientation process the heat energy was absorbed. Additionally, it implies that the association of two species results in the formation or breakage of hydrogen bonds in the mixture. In order to interpret the fluctuating values of ΔH it is convenient to consider the mixture as the systems of two heterogeneous hydrogen bonded networks. ΔH was

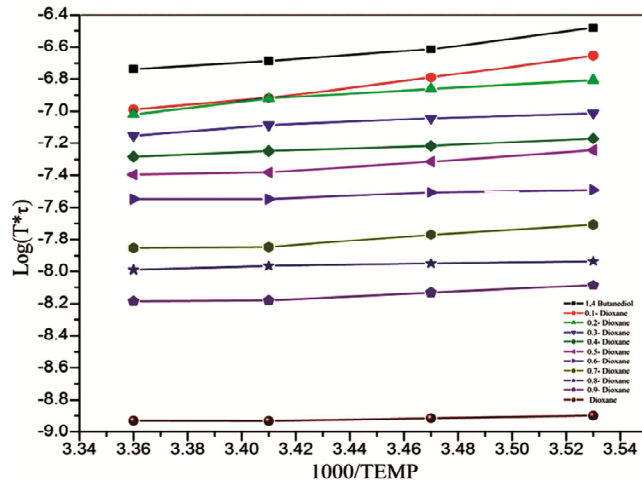

Fig. 7 — Arrhenius Plot of $\log(T * \tau)$ vs $1000/Temp$ in Kelvin for various volume fraction of dioxane

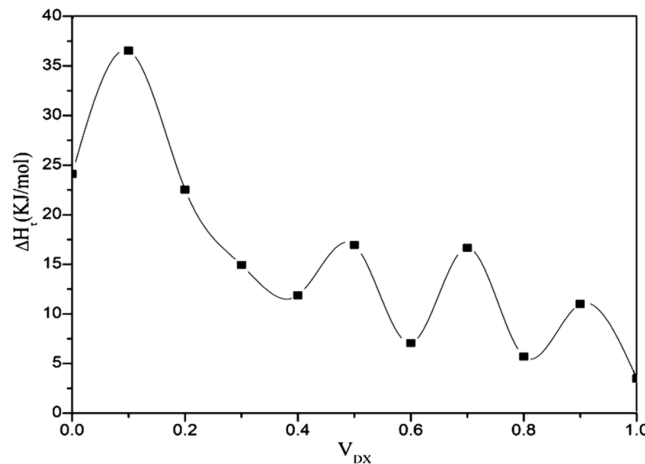

Fig. 8 — Activation energy ΔH vs volume fraction of dioxane.

found to be 24.12 kJ/mol for pure 1, 4-butanediol, which is equal to the amount of energy required to break a hydrogen bond.

3.6 Kirkwood Correlation Factor

The Kirkwood correlation factor gives information regarding dipole orientation in a liquid. The Kirkwood-Frohlich equation is used to calculate the dielectric constant for diol-dioxane mixtures in order to understand the amount of hydrogen bonds that exist between each alcohol and dioxane molecule is as follow²³.

$$\frac{(\epsilon_s - \epsilon_\infty)(2\epsilon_s + \epsilon_\infty)}{\epsilon_s(\epsilon_\infty + 2)^2} = g_i \mu^2 \frac{4\pi N \rho}{9kTM} \quad \dots(6)$$

($i=1$ or 2 represent 1,4BD and 1,4DX respectively) where, g_i = Kirkwood correlation factor, ϵ_s = static dielectric constant, ϵ_∞ = permittivity at high frequency, N = Avogadro's number, M = molecular weight, T = temperature, μ = dipole moment of the liquid, k = Boltzmann constant and ρ = density of the liquid. The interpretation of the dielectric constant for mixtures of associating liquids in terms of the Kirkwood correlation factor is quite difficult. It is difficult to separate the the average correlation factors g_1 and g_2 without making any assumptions from single value of static dielectric constant. Luzar suggested theoretical equations for hydrogen-bonded mixtures based on the theory of mean field approximation²⁴. The 1,4-butanediol-dioxane mixture is assumed to contain two different types of intermolecular hydrogen bonding, which modifies the Kirkwood correlation factors g_1 , g_2 for individual species. The following equations were used to calculate the correlation factors, g_1 and g_2 ^[24].

$$g_1 = 1 + Z_{11} \cos\phi_{11} + Z_{12} \cos\phi_{12} (\mu_2 / \mu_1) \quad \dots(7)$$

$$g_2 = 1 + Z_{21} \cos\phi_{21} (\mu_1 / \mu_2) \quad \dots(8)$$

where $Z_{11} = 2 \langle n_{HB}^{11} \rangle$, $Z_{12} = \langle n_{HB}^{12} \rangle$ and $Z_{21} = \langle n_{HB}^{21} \rangle V_{DX} / (1 - V_{DX})$ are the average number of particles involved in the formation of the hydrogen bonds with 1,4-butanediol-1,4-butanediol (pair 11), 1,4-butanediol -1,4-dioxane (pair 12) and 1,4-dioxane-1,4-Butanediol pairs, respectively. V_{DX} is the volume fraction of 1,4-dioxane. The neighboring dipole angles of the molecules 1,4-butanediol and 1,4-dioxane are ϕ_{11} and ϕ_{11} , respectively. The value of g_1 and g_2 depends on the volume fraction of 1,4DX in the 1,4BD-1,4DX mixtures as shown in Fig. 9. The number of hydrogen bonds on average $\langle n_{HB}^{11} \rangle$, $\langle n_{HB}^{12} \rangle$

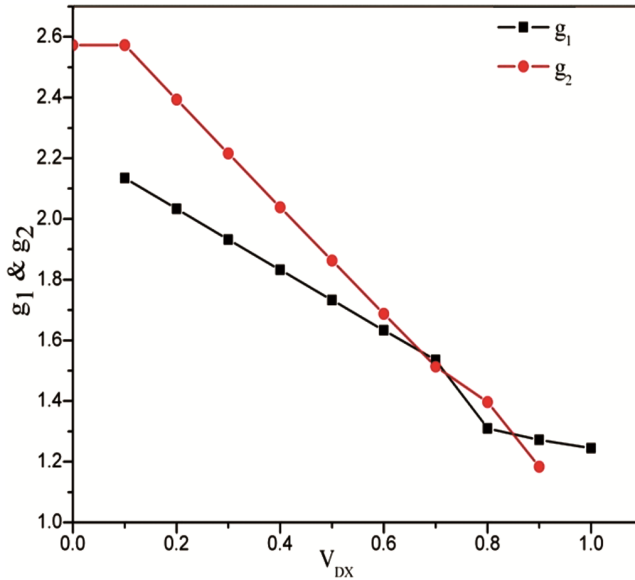

Fig. 9 — Correlation factors vs volume fraction of 1,4DX for the 1,4-BD+1,4DX system at 25 °C.

and $\langle n_{HB}^{21} \rangle$ per 1,4-Butanediol molecule for 1i pairs ($i = 1, 2$) were determined by the following relationship¹⁹

$$\langle n_{HB}^{1i} \rangle = n^{1i} \omega^{1i} / n_1, \quad \dots(9)$$

Where $\omega^{1i} = 1/(1 + \alpha^{1i} e^{-\beta E^{1i}})$ is the probability of formation of bonds between 1,4-BD and 1,4-DX. The 1,4-dioxane number density is n_1 . α^{1i} is the ratio between the two subvolumes of the phase space that correspond to the non-hydrogen-bonded and hydrogen-bonded couples and the value of β is $\beta = 1/kT$. The hydrogen-bonded pairs 11 and 12 formed, these pairs have different energy levels, E^{11} and E^{12} . The values of $\langle n_{HB}^{11} \rangle$ and $\langle n_{HB}^{12} \rangle$ depend on the amount of hydrogen bonding pair density between 1,4-Butanediol–1,4-dioxane n_{12} and those between 1,4-Butanediol –1,4-Butanediol molecule, i.e. $n_{11} = 2n_1 - n_{12}$ ^[24]. This can be calculated during which 1,4-Butanediol –1,4-Butanediol (pair 11) and 1,4-Butanediol–1,4-dioxane (pair 12) was formed²⁴. The average number of hydrogen bonds between pairs 11 and 12 is plotted against V_{DX} in Fig. 10. The values of $\langle n_{HB}^{11} \rangle$ and $\langle n_{HB}^{12} \rangle$ depend on the concentration of 1,4DX in the 1,4BD–1,4DX mixtures. The parameters required to compute the theoretical values by applying Luzar model²⁴ are polarizability, the possible number of hydrogen bonds, dipole moments, and angles between dipoles $\cos\phi_{11}$ and $\cos\phi_{12}$ for the 1,4 BD and 1,4DX. Table. 2 contains the best possible molecular parameter values based on our analysis. The calculated static dielectric constant and the

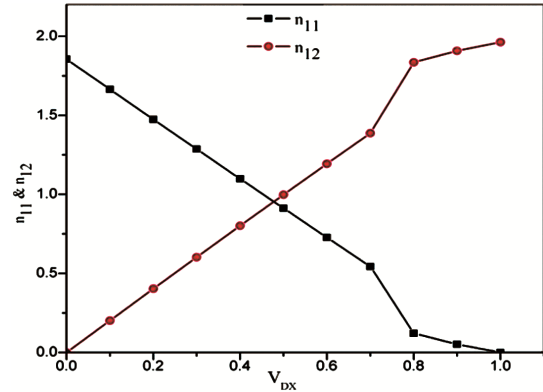

Fig. 10 — The average number of hydrogen bonds in 1,4BD-1,4BD (pair 11) and 1,4BD-1,4DX (pair 12) against V_{DX} .

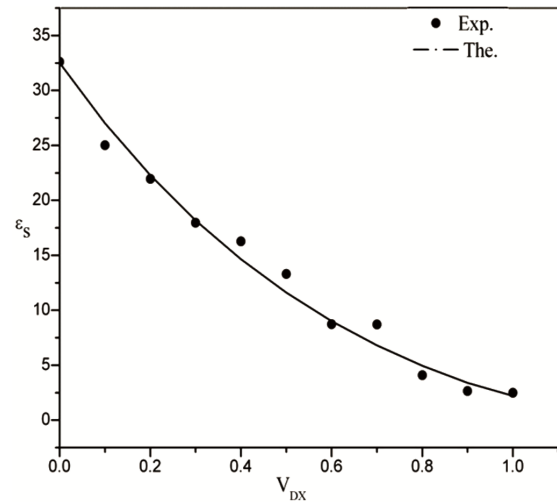

Fig. 11 — Static dielectric constant vs volume fraction of 1,4DX for the 1,4-BD+1,4DX system at 25 °C temperature.

Table 2 — The molecular parameters used in the calculation of the static dielectric constant.

Molecular Parameters	1,4-butanediol	1,4-dioxane
Density (g/cm^3)	1.017	1.028
Polarizability (α_1, α_2) in Å^3	9.96	2.79
Dipole moment (μ_1, μ_2) (Debye)	2.60	0.97
Enthalpy (α_{11}, α_{12}) (KJ/mol)	50	30
Binding energy (E_{11}, E_{12}) (KJ/mol)	-17	-18.25
Molecular weight (g/mol)	90.12	88.11

experimental values obtained using the TDR technique were found to be in good agreement and are shown in Fig. 11.

4 Conclusions

The temperature and frequency dependent complex permittivity spectra of BD-DX mixture have been studied using a TDR technique. The Kirkwood correlation factor, Bruggeman factor and excess parameter confirms the molecular interaction between

the constituents of mixture. The numbers of hydrogen bonds of BD-BD and BD-DX molecules are obtained from the dielectric constant.

Acknowledgement

The financial assistance received from the Department of Sciences and Technology (DST), New Delhi, through the project (SB/S2/LOP-032/2013). The University Grant Commission (UGC), New Delhi is gratefully acknowledged for providing financial support in the form of junior research fellowship to NPG.

References

- Zhuravlev V I, Usacheva T M, Lifanova N V & Vydrina E P, *Russ J Gen Chem*, 78 (2008) 1189.
- Mashalkar G V, Chalikwar P A & Kumbharkhane A C, *Phys Chem Liq*, 53 (2015) 307.
- Kadam S S, Kanse K S, Joshi Y S, Rander D N & Kumbharkhane A C, *Indian J Phys*, 92 (2018) 1367.
- Mehrotra S, Kumbharkhane A & Chaudhari A, *Binary polar liquids 1st edition*, Elsevier (2017).
- Sengwa R J, *J Mol Liq*, 123 (2006) 92.
- Shinde M N, Talware R B & Kumbarkhane A C, *Lithuanian J Phys*, 51 (2011).
- Chavan S, Kumbharkhane A & Mehrotra S, *J Chin Chem Soc*, 54 (2007) 1457.
- Sato T, Chiba A & Nozaki R, *J Mol Liq*, 101 (2002) 99.
- Lopes J A J, Rosado M T, Leitão M L P & Redinha J S, *J Phys Chem A*, 107 (2003) 3891.
- Joshi Y S, Rathod B A, Kanse K S & Kumbharkhane A C, *J Mol Liq*, 198 (2014) 347.
- Zhuravlev V I, Lifanova N V & Usacheva T M, *Russ J Phys Chem A*, 83 (2009) 151.
- Hanna F F, Gestblom B & Soliman A, *J Mol Liq*, 95 (2002) 27.
- Deshmukh A R, Shinde R V, Ingole S A, Pathan A W, Lokhande M P, Sarode A V and Kumbharkhane A C, *Indian J Pure Appl Phys*, 56 (2018) 346.
- Havriliak S & Negami S, *J Poly Sci Part C: Polymer Symposia*, 14 (1966) 99.
- Deshmukh A R & Kumbharkhane A C, *Indian J Phys*, 96 (2022) 1.
- Kaatz U, Pottel R & Schumacher A, *J Phys Chem*, 96 (1992) 6017.
- Navarkhele V V & Bhanarkar M K, *J Mol Phys*, 107 (2009) 1823.
- Grineva O V & Zhuravlev V I, *J Chem Eng Data*, 41 (1996) 604.
- Mohan A, Malathi M & Kumbharkhane A C, *J Mol Liq*, 222 (2016) 640.
- Ingole S A, Deshmukh A R, Shinde R V & Kumbharkhane A C, *J Mol Liq*, 272 (2018) 450.
- Puranik S M, Kumbharkhane A C & Mehrotra S C, *J Mol Liq*, 59 (1994) 173.
- Glasstone S, Laidler K J & Eyring H, *The theory of rate processes; the kinetics of chemical reactions, viscosity, diffusion and electrochemical phenomena*, (No 54139) McGraw-Hill Book Company, (1941).
- Kirkwood J G, *J Chem Phys*, 7 (1939) 911.
- Luzar A & Stefan J, *J Mol Liq*, 46 (1990) 221.